

Optical analysis of low concentration evacuated tube solar collector

Mavd R. Teles^{*}, Raquel Carvalho^a and Kamal A.R. Ismail^b

Department of Energy, Faculty of Mechanical Engineering, State of University of Campinas, Mendeleiev Street, 200, Cidade Universitária "Zeferino Vaz", Barão Geraldo, 13083-860, Campinas (SP), Brazil

(Received September 21, 2017, Revised February 2, 2018, Accepted April 3, 2018)

Abstract. The continuous increase of emission rates of green house gases and the effects on global warming added a new dimension to the problem of substituting the petroleum and its derivatives by environment friendly and sustainable energy sources for the world. Solar and wind energy appear at the top of the list of renewable of high potential, widely available, of dominated technology and well accepted. Brazil is one of the few countries in the world that receives number hours of sunshine exceeding 3,000 hours per year with a daily average of 4.5 to 6 kWh. However, this potential is largely unexplored and poorly tapped. The number of renewable systems implanted in Brazil has grown in recent years, but still insignificant when compared, for example, with Germany and Spain among others. This paper presents the results of an optical study on small concentration solar collector with evacuated tube enveloping the absorber and internal reflective surface fixed on the bottom part of the evacuated tube. The designed collector has a 2D geometrical concentration ratio between 2.455 and 4.91. The orientation of the solar collector, the ratio of the radius of the receiver to the radius of the absorber, the incidence angle for each period of the year, the collector inclination angle, the aperture angle of the reflective surface, concentration and optical efficiency were determined. The ray traces and flux distribution on the absorber of the evacuated tube solar collector were determined by using the program Ray Optics Simulation. The optical efficiency varies during the year according to the solar declination. For the periods were the solar declination is close to zero the efficiencies are maximum, and the variation during the day is around 25.88% and 99.9%. For the periods were the solar declination is maximum the efficiencies are minimum, and the variation during the day is around 23.78% and 91.79%.

Keywords: optical analysis; evacuated tube collector; low concentration collector; internal reflective surface

1. Introduction

The increase of the world's population together with the expansion of industrial activities in developing countries in the last half-century severely increased the demand for energy. To attend the global energy demands, engineers and researchers have been working on a wide range of renewable technologies to provide possible energy solutions for the world. Solar energy is one of

^{*}Corresponding author, Ph.D., E-mail: raquel.miguezcarvalho@gmail.com

the most promising renewable sources and can be converted directly to electricity by using photovoltaic systems or converted to heat which can be converted to electricity by thermal machines.

Brazil is one of the few countries in the world that received sunshine (number hours of sunshine) exceeding 3,000 hours per year with a daily average of 4.5 to 6 kWh in the Northeast region, (Carta Capital 2015). These figures put the country in the spotlight on the solar potential. However, this potential is largely unexplored and poorly tapped. The number of renewable systems implanted in Brazil has grown in recent years, but still insignificant when compared, for example, with Germany among others (Carta Capital 2015). For Brazil, it is important to continue investing in research and development to be able to advance in technologies and improve the energy efficiency of renewable systems. According to Kalogirou (2004) there are basically two types of solar collectors: stationary and nonstationary or tracking collectors. Stationary solar collectors permanently fixed and do not track the sun. Three types of collectors are more common in this category: Flat plate collectors (FPC), Stationary compound parabolic collectors (CPC); Evacuated tube collectors (ETC).

Evacuated tube collectors have better performance than flat-plate collectors for high temperature operation because of the reduced convection heat loss due to the vacuum envelope around the absorber surface. The market development for these collectors was initially slow due to the high manufacturing cost of sealing the glass-to-metal joints. This market expanded rapidly after the development of low cost sputter coating machines for applying a selective surface to the glass absorber surface.

A correlation of flow rate in terms of the tube geometry and operating conditions is an important parameter of a system simulation model for prediction of the long-term performance of water-in-glass systems. Budihardjo *et al.* (2007) conducted experimental and numerical investigations to develop a correlation for natural circulation flow rate through single ended water-in-glass evacuated tubes mounted over a diffuse reflector. The circulation flow rate was correlated in terms of the solar input, tank temperature, collector inclination and tube aspect ratio. The sensitivity of the flow rate correlation to the variation in circumferential heat flux distribution was also investigated.

Budihardjo and Morrison (2009) evaluated the performance of water-in-glass evacuated tube solar water heaters by measurements of optical and heat loss characteristics and simulation of the thermosyphon circulation in single-ended tubes. The performance of water-in-glass evacuated tube solar collector system was compared with flat plate solar collectors.

Shah and Bhatt (2014) presented a review on solar thermal technology based evacuated tube solar collector for heating liquid. Based on the review and discussions, the following could be concluded:

- Evacuated tube collector has better performance than flat plate solar collector for high temperatures and that even at low temperatures the efficiency per unit area of evacuated tubular collector is substantially greater.
- Evacuated tube collector with heat shield perform better than collector without heat shield.
- Water-in-glass evacuated tube collector has better performance than that of flat plate collectors but heat pipe collector has 15 to 20% higher efficiency than water-in-glass collectors.
- Water is the best working fluid for built in heat pipe amongst the all other fluids tested.
- Reverse flow in the water-in-glass evacuated tube solar water heaters occurs at night. Results showed that the larger the tilts angle of the collector, the higher the reverse flow rate.

Yadav and Bajpai (2011) investigated experimentally a solar powered air heating system using

one ended evacuated tube collector. A solar air heater containing forty evacuated tubes is used for heating purpose. The collector surface area is about 4.44 m^2 . The study was realized to find the effect of intensity of solar radiation and flow rate of air on the out let temperature of air. The obtained results showed that the system is highly effective for the heating and that the system was highly efficient for a certain flow rate of air.

Evacuated tube solar water heater systems are widely used in China due to their high thermal efficiency, simple construction requirements, and low manufacturing costs.

Pei *et al.* (2012) realized a comparison of evacuated tube solar water heater systems with and without a mini-CPC reflector. The results showed that for water at low temperature the evacuated tube solar water heater system without a mini-CPC reflector showed higher thermal and exergy efficiencies than the system with mini-CPC reflector. On the other hand, for water at high temperature the system with mini-CPC reflector showed higher thermal and exergy efficiencies.

The use of evacuated tube collectors is increasing day by day. The space requirement for mounting these collectors in congested cities is a problem faced by solar industry. Mounting the collectors on the wall in vertical orientation can be the easiest solution for the problem. For flat plate collectors it is essential that the inclination of the collectors should be based on the latitude of the place for better performance. But for evacuated tube collectors, there is no proof that the performance will be best for particular angle of inclination. Selvakumar and Somasundaram (2012) conducted experimental study on the evacuated tube collectors mounted at different angles of inclination. The temperature characteristics obtained as a result of the experiments showed that the performance does not vary with the angle of inclination.

This paper presents the results of an optical study on low concentration solar collector with evacuated tube enveloping the absorber and internal reflective surface fixed on the bottom part of the evacuated tube. The collector was designed with a 2D geometrical concentration ratio between 2.455 and 4.91. The orientation of the solar collector, the ratio between the radius of the receiver and the absorber, the incidence angle for each period of the year, collector inclination angle, reflective surface aperture angle, concentration and optical efficiency are determined.

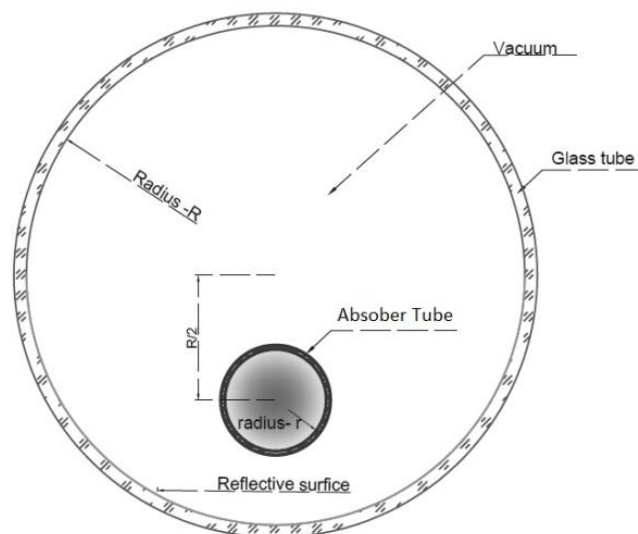

Fig. 1 Evacuated tube solar collector with low concentration

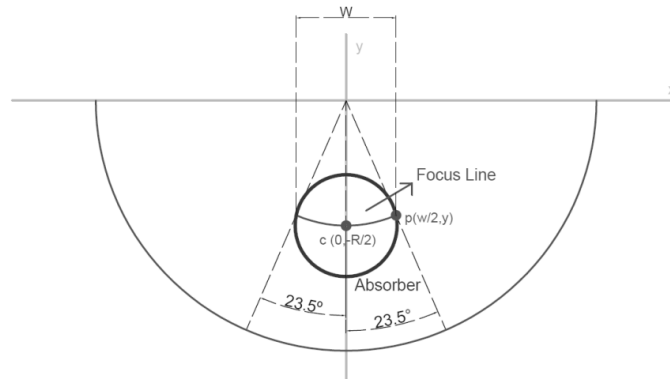

Fig. 2 Focus line for maximum and minimum angles the sun reaches in the East-West orientation

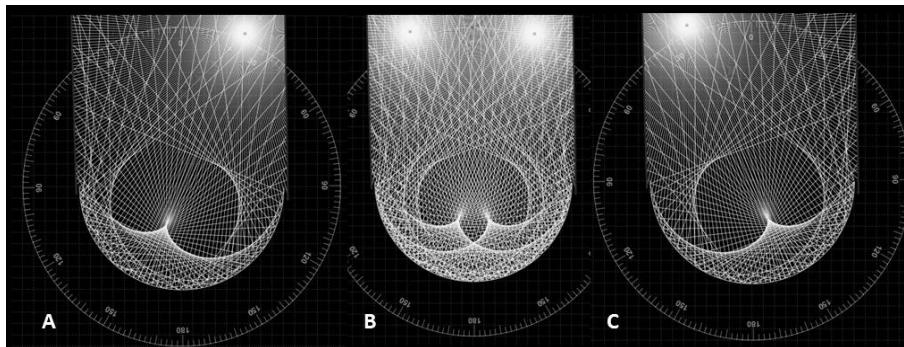

Fig. 3 Ray tracing. (A) Simulation of the Sun at 23.5° (B) Simulation of the sun at its two points at 23.5° and -23.5° (C) Simulation of the Sun at -23.5°

2. Solar collector model parameters

Fig. 1 shows a schematic diagram of an evacuated tube solar collector with low concentration considered in this study. For this model the orientation of the collector axis is along east-west direction, to allow the collector to remain fixed at a certain position throughout the year, Rapp (1981).

2.1 Collector mirror aperture

To determine the aperture angle of the mirror it is necessary to know the maximum latitude angles. According to Kreith and Kreider (1978) the tropic of cancer ($23\frac{1}{2}^\circ$ N) and Capricorn ($23\frac{1}{2}^\circ$ S) are the extreme latitudes where the sun reaches the earth at least once a year.

Thus a limitation for the mirror aperture would be at least the angular aperture of the sun's trajectory, since the orientation of the solar collector was defined as being east-west. In this case the minimum angle is 47° . However, such aperture is the only condition to the entry of direct irradiation. A solar irradiation is divided into direct and diffuse, and as in Dickinson and Cheremisnoff (1980) the solar concentrators that do not use tracking systems, need a large aperture angle so that they can collect significant diffuse radiation.

An aperture angle of 180° allows certain diffuse radiation and would not negatively affect the incident rays on the reflecting surface. Therefore, the aperture angle of the mirror was set at 180° .

2.2 Focus line and radius of the absorber

Based on Halliday and Renisck (2009) the focal distance of the spherical mirror is always half radius of the mirror in the direction of the incident ray. For the absorber to have the best possible absorption, it is necessary that for all variations of the sun angle relative to the mirror, the focus points must be contained within the surface of the absorber.

The maximum and minimum angles reached by the sun along the year are $\pm 23.5^\circ$. For this solar inclination aperture the mirror focus is limited by the maximum achieved angle of the sun and by the radius of the mirror as shown in the Fig. 2.

The value of the absorber minimum radius as a function of the radius of the mirror is determined from

$$r^2 = \frac{R^2}{4} [\sin^2(23.5^\circ) + (-\cos(23.5^\circ) + 1)^2] \quad (1)$$

To simulate the incidence of sunlight on the mirror and the corresponding ray trace, we used Ray Optics Simulation which is an open source web application to simulate reflection and refraction of light beams. The simulation results for the maximum and minimum angles are illustrated in Fig. 3.

2.3 Collector concentration

As in Kreith and Kreider (1978), the concentration ratio of a solar collector with concentration CR is defined by Eq. (2).

$$CR = \frac{A_r}{A_a} \quad (2)$$

In the previous section was obtained the relation between the minimum values for the absorber radius in terms of the collector radius. Considering the length of the collector the constraint is the internal convection in the tube for the laminar regime case according to Kreith and Bohn (2003). To avoid errors in the analytical results of Nusselt number it is necessary to have an $L/D > 100$, where L is the length tube and D it's diameter. Hence, the parameter that determines the length of the absorber and consequently the collector is the absorber radius. In view of this, Fig. 4 shows the concentration as function of the minimum radius for the projected area (two-dimensional) and total area (three-dimensional). The equations used for calculating the two and three dimensional concentration ratios are written below

$$CR_{2D} = \frac{A_r}{A_a} = \frac{2R_{reflect} L}{2r_{absorber} L} = \frac{R_{reflect}}{r_{absorber}} \quad (3)$$

$$CR_{3D} = \frac{A_r}{A_a} = \frac{\pi R_{reflector} (R_{reflector} + L)}{2\pi r_{absorber} (r_{absorber} + L)} \quad (4)$$

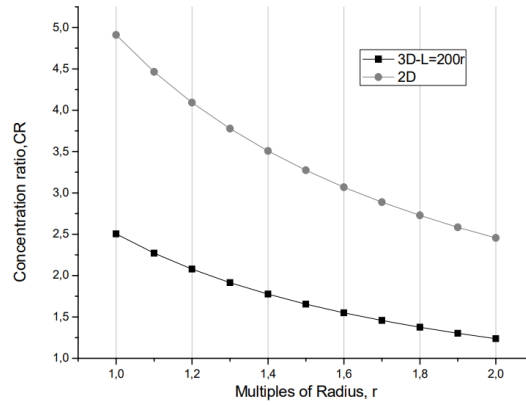

Fig. 4 Concentration per variation of absorber radius with an increment of 0.1 for 2D and 3D area

Table 1 Variation of the concentration due to absorber radius and length

Parameter	(% de R)	3D			2D
		L=200r	L=300r	L=400r	Independent of L
Minimum	20.36	2.5031	2.4872	2.4792	4.9106
Maximum	40.73	1.2365	1.2336	1.2321	2.4553

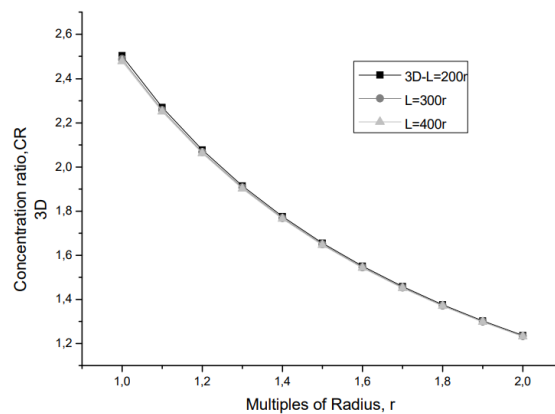

Fig. 5 Concentration in function of the variation of absorber radius for ratios length

The decay of the concentration curve for the three-dimensional case is smaller than that for two-dimensional case. For thermal analysis the collector length required is assumed bigger than $L=200r$. Hence to investigate the effect of the absorber length on the concentration ratio, Fig. 5 was prepared for $L=200r$ and $L=400r$. As can be verified the absorber length did not affect the concentration ratio. Table 1 shows the effect of varying the absorber length and the absorber radius on the concentration ratio.

3. Collector orientation angle and angle of incidence

According to Kreith and Kreider (1978) the orientation angles of the collector denominated as β

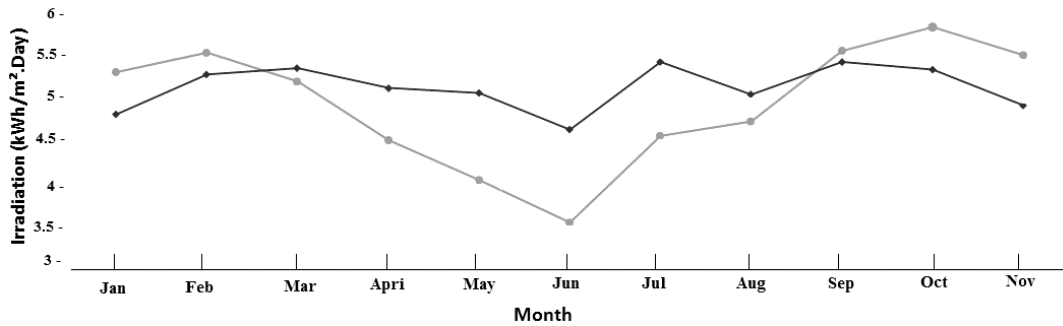

Fig. 6 Solar incidence in the city of Campinas with horizontal and inclined plane

(collector slope angle) and a_w (collector’s azimuth); are dependent on the solar angles: δ_s (angle of declination of the sun), h_s (solar hour angle), L (latitude), a_s (sun azimuth) and i (angle of incidence). They can be related by Eq. (5)

$$\cos i = \sin \delta_s (\sin L \cos \beta - \cos L \sin \beta \cos a_w) + \cos \delta_s \cos h_s (\cos L \cos \beta + \sin L \sin \beta \cos a_w) + \cos \delta_s \sin \beta \sin a_w \sin h_s \tag{5}$$

To determine the fixed inclination angle of the collector, knowledge of the other angles is necessary. The declination angle is determined according to the date and time of the year; hence, it is necessary to choose the date for the location of the solar collector. The choice of this date was made according to the dates of maximum incidence of solar irradiation and with the minimum variation of solar elevation. According to Rapp (1981) for east-west orientation the days for which the focus remains constant all day are in the first day of autumn and spring. According to the data from Crescesb/Cepel (2017) the solar irradiation for the city of Campinas for the horizontal and inclined surfaces is shown in Fig. 6.

The spring and autumn seasons of the year 2017 for Brazil occurred on the dates September 22nd and March 20th, respectively (INMET 2017). From these data the chosen date for the city of Campinas is September 22, 2017 at solar noon. For this date, according to Nautical Almanac of the Stars (2017), the declination angle of the sun is $\delta_s = 0^\circ 7.8'$.

Thus, using $a_w = 0^\circ$, the best slope angle of the collector was calculated for one of the highest incidence dates for Campinas, which is close to the latitude value as shown below.

Best value of β for on September 22 at noon

$$\alpha = 67.35^\circ, a_w = 0^\circ, \delta_s = 0.1167^\circ, i = 0^\circ$$

$$a_s = 5.173E - 09, \beta = -22.58^\circ, h_s = 0^\circ, L = -22.53^\circ$$

3.1 Optical efficiencies

In the case of a solar collector, the optical efficiency is the ratio of the incident energy to the absorbed energy.

According to Kreith and Kreider (1978) the direct solar irradiation intercepted by the surface of the solar collector is given by

$$I_{b,c} = I_b \cos(i) \tag{6}$$

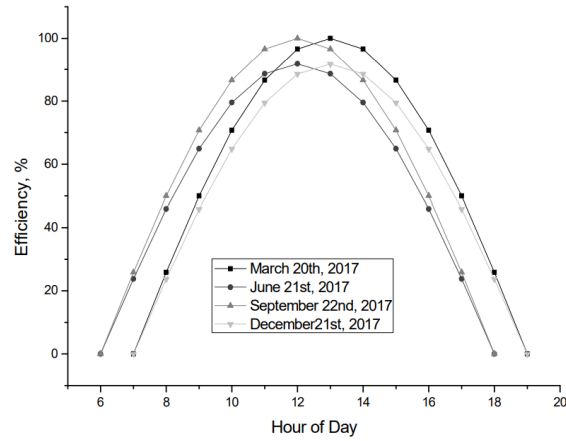

Fig. 7 Hourly efficiency; for relevant dates of the year- Campinas-SP

Table 2 Hourly efficiency during a day for the relevant dates along the year

Hour of Day	Efficiency (%)			
	March, 20	June, 20	September, 22	December, 21
6	0.00	0.03	0.00	
7	0.00	23.78	25.88	0.03
8	25.88	45.91	50.00	23.71
9	50.00	64.91	70.71	45.84
10	70.71	79.49	86.60	64.84
11	86.60	88.66	96.59	79.43
12	96.59	91.79	99.90	88.59
13	99.90	88.66	96.59	91.72
14	96.59	79.49	86.60	88.59
15	86.60	64.91	70.71	79.43
16	70.71	45.91	50.00	64.84
17	50.00	23.78	25.88	45.84
18	25.88	0.03	0.00	23.71
19	0.00			0.03
Average	69.05	53.64	69.05	53.58

Hence, the optical efficiency of the collector is

$$\eta_{op} = \frac{I_{b,c}}{I_b} = \frac{I_b \cos(i)}{I_b} = \cos(i) \quad (7)$$

where I_b is the incident solar radiation.

Since it is possible to determine the angle of incidence of the collector throughout the day for each period of the year, one can calculate the optical efficiency. The optical efficiency for the most

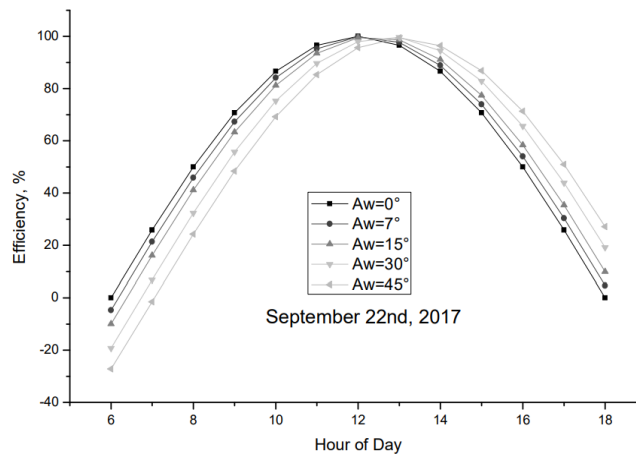

Fig. 8 Efficiency per hour with variation of collector's azimuth Campinas-SP

relevant periods of the year for the city of Campinas-SP is shown in Fig. 8. The variation of the efficiency is shown in Table 2. The period for high efficiency is the spring and autumn seasons.

Typical result for the hourly variation of efficiency in one day is shown in Fig. 8. As can be seen varying a_w can shift the efficiency curve along the horizontal axis and consequently the time when the maximum efficiency occurs. This artifice can be used to satisfy specific energy demand during certain period of the day.

4. Conclusions

In this study the relation between the reflector and absorber radius was developed and their minimum and maximum values were found adequate for evacuated tube solar collectors.

The optical concentration of the collector was found be unaffected by the absorber length. Hence the absorber length can be determined by thermal criterion.

The inclination angle of the collector can be determined constrained to maximum efficiency along certain period of the year. If the period is changed new calculations must be realized.

Variation of the maximum efficiency during a year is around 8% while the hourly variation of the efficiency is considerable. The optical efficiency varies during the year according to the solar declination variation. For the periods were the solar declination is close to zero the efficiencies are maximum, and the variation during the day is around 25.88% and 99.9%. For the periods were the solar declination is maximum the efficiencies are minimum, and the variation during the day is around 23.78% and 91.79%.

Variation of the azimuth angle can be used to enhance solar collector in a certain period of the day to satisfy a certain energy demand.

Acknowledgments

The authors wish to thank the Fapema for the master grant to the first author, CNPQ for the master grant to the second author and the PQ Research Grant to the third author.

References

- Budihardjo, I. and Morrison, G.L. (2009), "Performance of water-in-glass evacuated tube solar water heaters", *Solar Energy*, **83**(1), 49-56.
- Budihardjo, L., Morrison, I. and Behnia, M. (2007), "Natural circulation flow through water-in-glass evacuated tube solar collectors", *Solar Energy*, **81**(12), 1460-1472.
- Carta Capital (2015), *Brazil*, <<https://www.cartacapital.com.br/blogs/outras-palavras/por-que-a-energia-solar-nao-deslanca-no-brasil-3402.html>>.
- Crescesb/Cepel. (2017), *Centro de Referências para Energia Solar e Eólica Sérgio de S. Brito*, Eletrobras Cepel, Brazil, <<http://cresesb.cepel.br/index.php?section=sundata>>.
- Grodzka, P.G. (1980), *Solar Energy Technology Handbook- Part A Engineering Fundamentals*, Marcel Dekker, New York, U.S.A.
- Halliday, D., Resnick, R. and Walker, J. (2009), *Fundamentals of Physics, Part. 4*, LTC, Rio de Janeiro, Brazil.
- INMET (2017), *Instituto Nacional de Meteorologia, Ministério da Agricultura, Pecuária e Abastecimento*, Brazil, <[http://www.inmet.gov.br/portal/index.php?r=home2/page&page=estacoesDoA no](http://www.inmet.gov.br/portal/index.php?r=home2/page&page=estacoesDoA%20no)>.
- Kalogirou, S.A. (2014), *Solar Energy Engineering: Processes and Systems*, Elsevier, Oxford, U.K.
- Kalogirou, S.A. (2004), "Solar thermal collectors and applications", *Prog. Energy Combust. Sci.*, **30**(3), 231-295.
- Kreith, F., Manglik, R.M. and Bohn, M.S. (2003), *Principles of Heat Transfer*, Thomson, São Paulo, Brazil.
- Kreith, F. and Kreider, J.F. (1978), *Principles of Solar Engineering*, Hemisphere Publishing Corporation, Washington, D.C., U.S.A.
- Nautical Almanac of the Stars. (2017), *National Almanac, Italy*, <<https://www.nauticalalmanac.it/en/navigation-astronomy/the-nautical-almanac.html>>.
- Pei, G., Li, G., Zhou, X., Ji, J. and Su, Y. (2012), "Comparative experimental analysis of the thermal performance of evacuated tube solar water heater systems with and without a mini-compound parabolic concentrating (CPC) reflector ($C < 1$)", *Energies*, **5**(4), 911-924.
- Rapp, Donald. (1981), *Solar Energy*, Prentice-Hall, Englewood Cliffs, New Jersey, U.S.A.
- Selvakumar, P. and Somasundaram, D.P. (2012), "Effect of inclination angle on temperature characteristics of water in-glass evacuated tubes of domestic solar water heater", *J. Eng. Innov. Technol.*, **1**, 78-81.
- Shah, V. and Bhatt, N. (2014), "Review on evacuated glass tube based solar liquid heaters", *J. Eng. Dev. Res.*, **2**, 2727-2733.
- SunCalc. (2017), *Kiev, Ukraine*, <<http://suncalc.net/#/-22.9078,-47.0544,3/2017.09.22/12:00>>.
- Yadav, A. and Bajpai, V.K. (2011), "An experimental study on evacuated tube solar collector for heating of air in India", *World Acad. Sci. Eng. Technol.*, **79**, 81-86.

CC

Nomenclature

a_s	Solar's azimuth angle, °
a_w	Collector's azimuth angle, °
CR	Concentration
h_s	Solar hour angle, °

i	Incidence angle, °
I_b	Solar direct irradiation, W/m ²
$I_{b,c}$	Solar direct irradiation intercepted by the collector, W/m ²
L	Length, m
L	Latitude, °
N	North
r	Absorber radius, m
R	Cover radius, m
S	South

Greek symbols

β	Slope angle
δ_s	Solar declination
η_{op}	Optical efficiency

Subscripts

$2D$	Two dimensional
$3D$	Three dimensional
r	Reflective surface
a	Absorber