

Stochastic identification of masonry parameters in 2D finite elements continuum models

Giada Bartolini^{*1}, Anna De Falco^{2a} and Filippo Landi^{2b}

¹Department of Energy, Systems, Territory and Construction Engineering, University of Pisa,
Largo Lucio Lazzarino, 2, 56122 Pisa, Italy

²Department of Civil and Industrial Engineering, University of Pisa, Largo Lucio Lazzarino, 2, 56122 Pisa, Italy

(Received April 1, 2023, Revised July 15, 2023, Accepted July 29, 2023)

Abstract. The comprehension and structural modeling of masonry constructions is fundamental to safeguard the integrity of built cultural assets and intervene through adequate actions, especially in earthquake-prone regions. Despite the availability of several modeling strategies and modern computing power, modeling masonry remains a great challenge because of still demanding computational efforts, constraints in performing destructive or semi-destructive in-situ tests, and material uncertainties. This paper investigates the shear behavior of masonry walls by applying a plane-stress FE continuum model with the Modified Masonry-like Material (MMLM). Epistemic uncertainty affecting input parameters of the MMLM is considered in a probabilistic framework. After appointing a suitable probability density function to input quantities according to prior engineering knowledge, uncertainties are propagated to outputs relying on gPCE-based surrogate models to considerably speed up the forward problem-solving. The sensitivity of the response to input parameters is evaluated through the computation of Sobol' indices pointing out the parameters more worthy to be further investigated, when dealing with the seismic assessment of masonry buildings. Finally, masonry mechanical properties are calibrated in a probabilistic setting with the Bayesian approach to the inverse problem based on the available measurements obtained from the experimental load-displacement curves provided by shear compression in-situ tests.

Keywords: Bayesian updating; continuum models; gPCE; historical masonry; in-plane behavior; modified masonry-like material; sensitivity analysis; uncertainty quantification

1. Introduction

The comprehension and modeling of the behavior of historical masonry structures is a tall order due to the difficulty of adequately describing the characteristics of masonry given the presence of significant material, modeling, and geometrical uncertainties, with often a limited possibility of carrying out destructive tests (Krentowski *et al.* 2023). At the same time, a proper simulation of mechanical behavior is fundamental to intervene with suitable actions and maintain the integrity of

*Corresponding author, Ph.D. Student, E-mail: giada.bartolini@phd.unipi.it

^aProfessor, E-mail: anna.de.falco@unipi.it

^bPh.D., E-mail: filippo.landi@ing.unipi.it

the structure, especially in seismic-prone areas (Formisano *et al.* 2023).

Scientific research has progressed greatly in the past 20 years with the tremendous advancement in the computational capabilities and development of increasingly sophisticated modeling strategies (Roca *et al.* 2010). Notwithstanding, the characterization of masonry still remains an issue and the choice of the modeling technique still reckons with the availability of data to feed models. Among various approaches, Finite Element Method (FEM) represents a good compromise among many elements at stake, namely model accuracy, computational burden, need for relatively limited material parameters from experimental testing among others (Saloustros *et al.* 2015, Asteris and Plevris 2015), and is the most widespread numerical tool for structural analyses.

Particularly FE models based on continuum mechanics are widely used also among practitioners thanks to the relative simplicity in the description of masonry. In fact, it is accounted for as an equivalent homogenized continuum body capable of deforming, thus reducing the necessity for carrying out time-consuming/ resource-intensive destructive tests on different masonry components. In this sense, FE continuum models belong to macromodels, where no distinction between bricks or stones and mortar is made.

Several non-linear constitutive laws are proposed in the framework of continuum macromodeling of masonry, and are based on plasticity (Dragon and Mróz 1979, Lourenço *et al.* 1998) damage mechanics (Løland 1980, Papa 1996, Berto *et al.* 2002, Mazars 1984) fracture mechanics with smeared crack approaches (Hillerborg *et al.* 1976) or local crack-cracking algorithms (Clemente 2006, Clemente *et al.* 2006, Saloustros *et al.* 2015, Saloustros *et al.* 2018) or plastic-damage models (Lubliner *et al.* 1989, Lee and Fenves 1998). Some of them, like the latter, have been originally developed for the simulation of concrete and later adapted for masonry, while others are suitable for solids with low tensile resistance.

In this paper, the Modified Masonry-like Material, which is the implemented version of the no-tension stress material of Di Pasquale (1982) through the introduction of the bounded shear stress, and a limited tensile resistance, is adopted (Lucchesi *et al.* 2018b). The isotropic material considers damage on the basis of the exceeding of a chosen stress value as explained in Section 2.1.

Particularly, the Modified Masonry-like Material is here used to evaluate its ability to reproduce the mechanical behavior of structures in terms of failure modes. In fact, said constitutive law is utilized to simulate the response of a masonry panel in shear-compression, which is characterized by a recurrent static scheme in literature and the availability of a large amount of data, thanks to some in-situ tests carried out as part of the seismic evaluation of many school buildings in Florence, Italy (Beconcini *et al.* 2021). The panel was subject to an increasing horizontal force with constant vertical load to reproduce the experimental behavior.

Within this context, given the uncertainty that often affects the mechanical properties of historical masonry, a probabilistic framework, see Section 2.1, is set to account for their inner variability (Sýkora and Holický 2010, Sykora *et al.* 2013, Croce *et al.* 2021b), and the effect of such variations on outputs is evaluated through sensitivity analysis.

The inputs in the Modified Masonry-like Material are expressed in probabilistic terms according to engineering judgment and prior knowledge about their variability. Thanks to the so-defined probabilistic framework, global Sensitivity Analyses (SA) to quantify the influence of uncertain input mechanical parameters on the response are performed by computing Sobol' Indices (SI_s) (Sudret 2008, Saltelli 2008, Sudret and Mai 2015), as described in Section 2.3. To reduce the number of analyses and efficiently perform the evaluation of SI_s we defined the surrogate model of

the response, an analytical replica of the numerical FE model, which expresses the relationship between output quantity of interest and inputs in mathematical terms. The definition of the approximated response surface builds upon the general Polynomial Chaos Expansion (gPCE) (Wiener 1938, Marzouk *et al.* 2007, Sudret 2015, Ghanem and Red-Horse 2017).

Finally, the inverse problem is solved by leveraging the Bayesian approach (Tarantola 2005, Matthies *et al.* 2016, Matthies *et al.* 2016), thus allowing us to update the prior *pdfs* or input parameters to the posterior version based on the experimental load-displacement curves from the shear compression in-situ tests (Section 2.4). The proposed methodology is applied to a relevant case study in Section 3.

2. Material and methods

2.1 Numerical simulation procedure

The Modified Masonry-Like Material sees its first formulation in the no-tension material (Di Pasquale 1982, Di Pasquale 1984, Como and Grimaldi 1985, Romano and Romano 1985, Lucchesi *et al.* 2008) and it is suitable to describe the behavior of solid incapable or scarcely capable of withstanding tensile stresses, such as masonry.

The initial formulation of the no-tension material is that of an isotropic non-linear elastic material with infinite compressive resistance, and zero tensile resistance. Since the material cannot take any positive (tensile) value, the stress tensor is negative semidefinite. Moreover, the strain tensor is given by the sum of an elastic component and an inelastic part. The first is proportional to the current stress level, and the second represents the occurrence of a fracture for the exceeding of the tensile stress.

Subsequent refinements of the original constitutive law regarded the introduction of a restriction to the attainable tensile and compressive stresses (Lucchesi *et al.* 2008) so that limited tensile and compressive stresses can be reached. Further developments entailed the definition of a limit to the tangential (shear) stress (Lucchesi *et al.* 2017, Lucchesi *et al.* 2018a).

In the current paper, the constitutive law adopts the more advanced formulation of the Masonry-like Material with bounded shear, compressive, and tensile stresses, whose implementation in the FE MADY code (Lucchesi *et al.* 2017b) allows the real failures to be better reproduced. The code relies on the explicit formulation of the Modified Masonry-like Material in the isotropic 2D, and 3D case. A Newton-Raphson iterative procedure is used to find the solution of the nonlinear system deriving from the discretization of the structure into finite elements. For each area, the tangent stiffness matrix is evaluated by explicitly computing the derivative of the stress with respect to the strain. Fig. 1 shows the domains of the original no-tension material and the implemented one. The latter is still a “normal elastic material” (Del Piero 1989) hyper-elastic and stress-bounded, and belongs to the 'deformation theory of plasticity' (Kachanov 2004).

The Modified Masonry-Like Material model is characterized by the following mechanical input parameters: compressive (f_m) and tensile strength (f_t), cohesion (f_{v0}), tangent of the friction angle (μ) and elastic properties (Young's modulus E and Poisson's ratio ν). The characterization of these parameters is often based on previous practices without performing a proper calibration that considers their expected variability and the experimental data. In the following section, a probabilistic framework is proposed. Firstly, it is aimed to evaluate the sensitivity of the model response to the variation of the input parameters. This is useful to understand which of them have

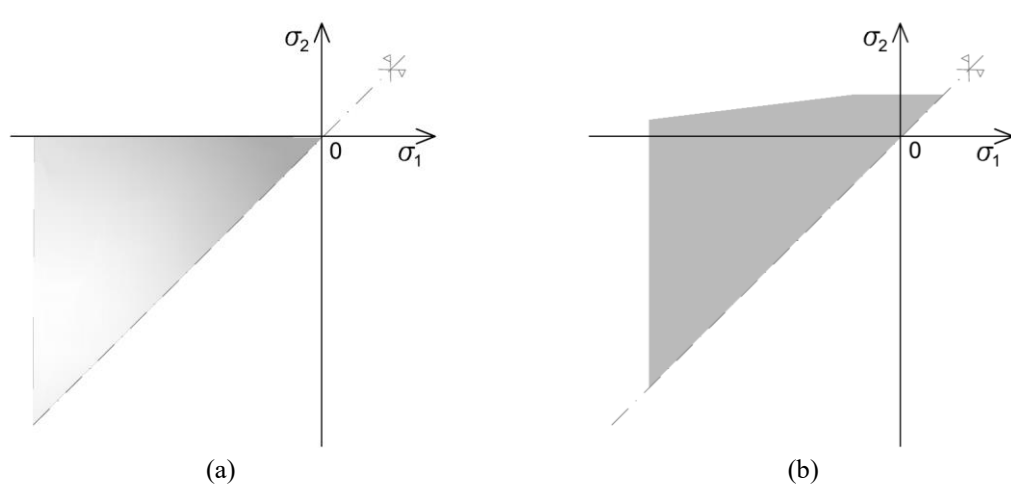

Fig. 1 Failure domain of the first formulation of the no-tension material (a), Failure domain of the more advanced version of the MMLM (b)

more influence on the output quantity of interest, and thus are worthy of further investigation to be better characterized. Then, the Bayesian updating is presented as the final step of the method to adequately calibrate the mechanical parameters by using available measurements.

2.2 Probabilistic framework for the assessment and calibration of masonry material

The steps of the probabilistic framework defined for the evaluation of the effects of the variation of masonry mechanical parameters in relation to the uncertainties that normally affect such material and their calibration based on experimental measurements can be synthesized as follows with reference to Fig. 2:

- Choice of suitable prior *pdfs* of the mechanical properties of masonry based on expert judgment and available a priori knowledge,
- Solution of the forward problem relying on the surrogation of the response, i.e., by generating the analytical surface of the outcomes,
- Computation of Sobol' Indices (SI_s) to evaluate the global sensitivity of the model (outputs) in dependence of the variation of input parameters,
- Calibration of the FE model by tapping into measurements from experimental campaigns to update prior *pdfs* and define new posterior *pdfs*, with the aim of better matching theoretical and experimental outcomes.

2.1.1 gPCE-based surrogate model

In this paper, the probabilistic framework within which the propagation of input uncertainties to outputs and the model calibration are carried out relies on the definition of a gPCE-based surrogate model (Xiu and Karniadakis 2002, Xiu 2010). The latter, belonging to spectral methods for uncertainty expansion, is based on the reconstruction of a multidimensional response surface through a particular basis of the probability space made of polynomials chosen from the Askey scheme, which are orthogonal with respect to the underlying probability measure defined by the a-priori input random variables.

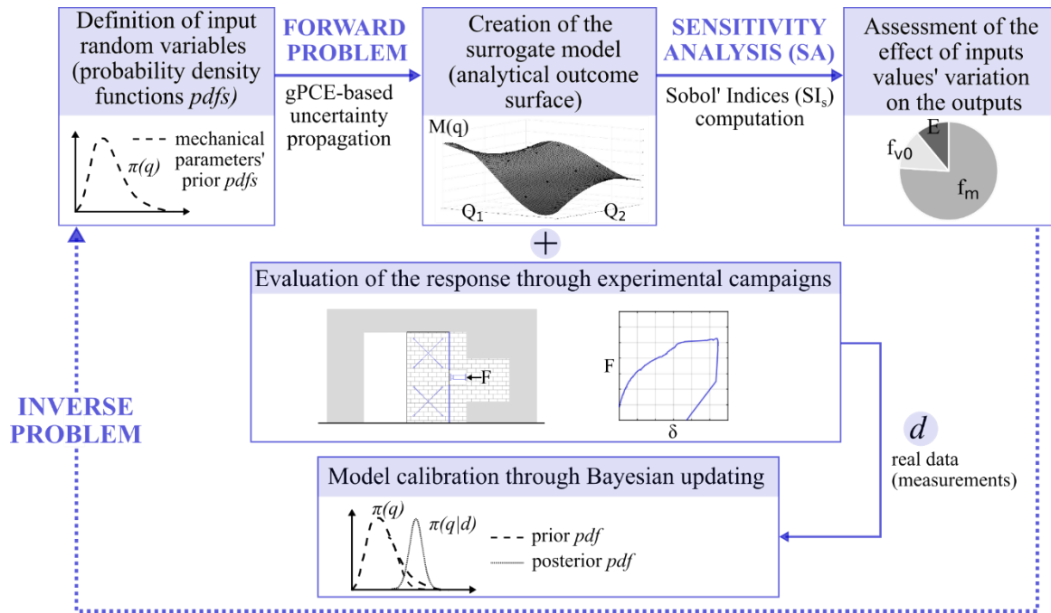

Fig. 2 Probabilistic framework for mechanical parameters calibration

An analytical representation of the predicted measurable response replaces the map, which makes the computational costs more affordable even when the runs of the FE model are highly demanding. In fact, only a limited number of deterministic solver calls of the FE model (P) evaluated at the collocation points of the monomial cubature rule (MCR) are required, according to the grade of the polynomial expansion (n) and the number of input RVs (k), $P = (n + 1)^k$ (Wei 2008).

2.2.2 Sensitivity Analysis (SA) through Sobol' indices (SIs)

A variance-based global sensitivity analysis (SA) to estimate the global impact of input uncertainties was performed in terms of first-order Sobol' Indices, which allowed us to decompose the variation of the model output into different contributions caused by different input parameters (Saltelli and Sobol' 1995, Sobol 2001).

Even if SI_s can be computed through a Monte Carlo Simulation (MCS) (Sobol 2001), this approach is unfeasibly burdensome because of the necessity of running the FE models as many times as many the samples of the input parameters there are to build the corresponding output distribution. However, the gPCE-based surrogate model allows us to overcome this issue, by analytically computing SI_s (Sudret 2008).

2.2.3 The Bayesian approach to the inverse method

The calibration of input parameters is here made possible by the availability of load and displacement data from in-situ tests carried out on the investigated masonry panel (Beconcini *et al.* 2021).

Particularly, the inverse problem, which entails the updating of the prior distributions of input variables based on the measurements of output quantities, builds upon the use of Bayes' theorem within a probabilistic framework.

Let M be the forward model. The relationship between the vector of input random parameters \mathbf{Q} and the observable \mathbf{u} given by M reads as

$$\mathbf{u} = M(\mathbf{q}), \quad G: R^k \rightarrow R^m \quad (1)$$

where $\mathbf{u} \in R^m$ is a vector gathering the response quantities and M is the forward model (FE Mady code). Particularly, the assumption of the existence of a deterministic solver that has \mathbf{q} as a set of inputs and returns a unique response vector \mathbf{u} is made. M generally, does not have an explicit form, so the numerical solution of some partial equation is required. At any rate, here M is referred to in general terms with no reference to a specific formulation. Since measurement errors are intrinsic in the data measurement process, observable data \mathbf{d} may not match exactly the response true value u .

Thus, if we consider additional unavoidable observational errors ε , the relationship between real data \mathbf{d} , computational model M , and its outcomes \mathbf{u} , and the error ε is

$$\mathbf{d} = \mathbf{u} + \varepsilon = M(\mathbf{Z}) + \varepsilon, \quad (2)$$

where $\varepsilon \in R^m$ is one realization of a random vector $\mathbf{E}: \Omega \rightarrow R^m$ modelling the measurement error. Here, we assume \mathbf{E} to be some mutually independent Gaussian random variables with joint pdf

$$\pi_{\mathbf{E}}(\varepsilon) = \prod_{i=1}^m \pi_{\varepsilon_i}(\varepsilon_i). \quad (3)$$

The Bayesian approach estimates the updated density of the random vector \mathbf{Q} given a set of observations \mathbf{d} . The Bayes rule can be written by

$$\pi(\mathbf{q}) = \frac{\pi(\mathbf{d}|\mathbf{q})\pi(\mathbf{q})}{\int \pi(\mathbf{d}|\mathbf{q}')\pi(\mathbf{q}')d\mathbf{q}'} \quad (4)$$

where $\pi(\mathbf{q})$ is the prior probability density of \mathbf{Q} , $\pi(\mathbf{d}|\mathbf{q})$ the likelihood function, and $\pi(\mathbf{q}|\mathbf{d})$ the density of \mathbf{Q} conditioned by the data \mathbf{d} (posterior probability density of \mathbf{Q}). Equation (5) presumes \mathbf{Q} and \mathbf{d} to have a joint pdf, which does not generally exist since \mathbf{d} is a function of \mathbf{Q} , unless the observational error is a discrete white noise process, that is uncorrelated. In this case, the model for the random variable representing the error ε determines the existence of the likelihood function

$$L(\mathbf{q}) = \pi(\mathbf{d}|\mathbf{q}) = \prod_{i=1}^m \pi_{\varepsilon_i}(d_i - M_i(\mathbf{q})) = \prod_{i=1}^m \pi_{\varepsilon_i}(d_i - u_i). \quad (5)$$

At any rate, the posterior distribution $\pi(\mathbf{q}|\mathbf{d})$ does not have a closed form and numerical methods need to be employed for its estimation. In the case at hand, the Markov Chain Monte Carlo (MCMC) method is used. It samples from the posterior distribution with a random walk and builds a Markov chain with the desired pdf as its equilibrium distribution (Tierney 1994). The method, despite being characterized by slow convergency, is a solid method within the civil engineering field (Landi *et al.* 2021).

On the whole, it is feasible when the model requires only one update, as in the present case. The computation of the acceptance probability r of each step j of the random walk given by

$$r = \min \left\{ 1, \frac{L(\mathbf{q}^{(j+1)})\pi(\mathbf{q}^{(j)})}{L(\mathbf{q}^{(j)})\pi(\mathbf{q}^{(j+1)})} \right\}, \quad (6)$$

which requires the computation of $L(\mathbf{q})$ in Eq. (5) and the evaluation of the model response for each sample drawn from the prior distribution, making the process computationally demanding. Nonetheless, having a surrogate model the sampling can be made efficient making the procedure significantly faster (Rosić *et al.* 2013).

3. Numerical experiment and discussion

3.1 Case study

The MMLM constitutive law is tested on a real case study of a masonry panel, which is housed in the four-story masonry primary school “Cairoli Alamanni” dating back to the early twentieth century and located in Florence (Italy).

The case study panel was tested through a shear compression in-situ experimental campaign involving the assessment of the seismic safety of more than 80 schools in Florence (Croce *et al.* 2021a, Beconcini *et al.* 2021). Fig. 3 shows the geometrical features and mechanical properties of the panel derived through surveys and the combination of single and double flat jack tests.

Moreover, Fig. 3 displays the mesh adopted for the investigated panel. The outer darker framework is modeled by linear elastic material since it falls outside the experimentally tested panel. On the other hand, the inner lighter part is modeled through the Modified Masonry-Like Material.

The numerical model accounts for the real panel frame within the whole inter-floor masonry wall. This configuration alone is not sufficient to attain the effective compressive stress σ_0 and hence an additional uniformly distributed vertical load is applied.

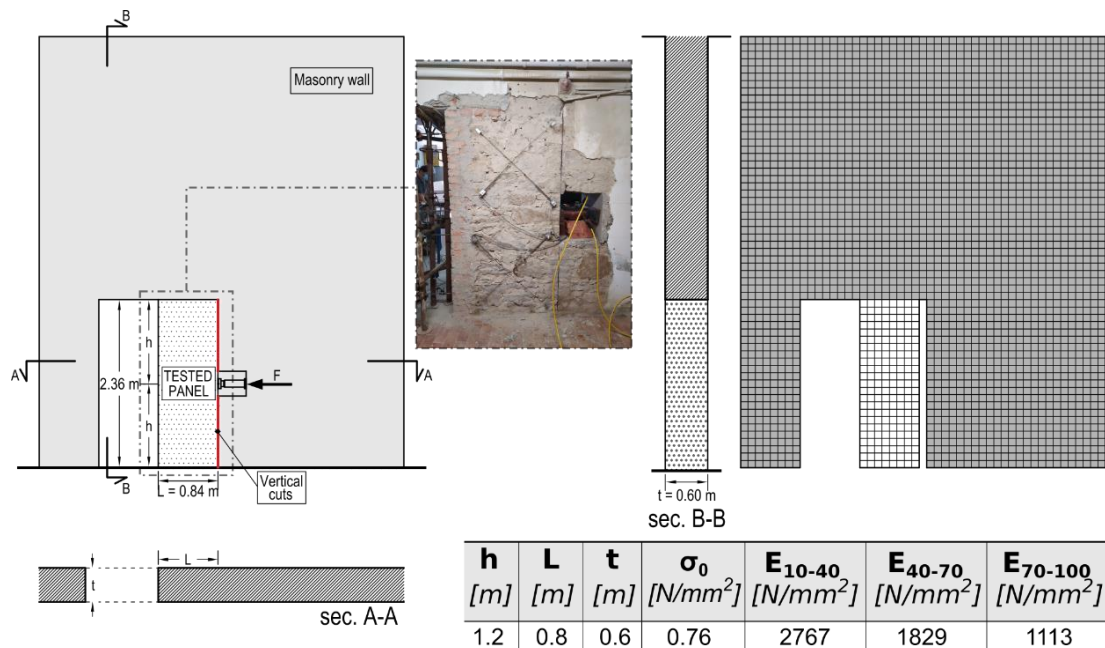

Fig. 3 Geometry and FE mesh of the case study

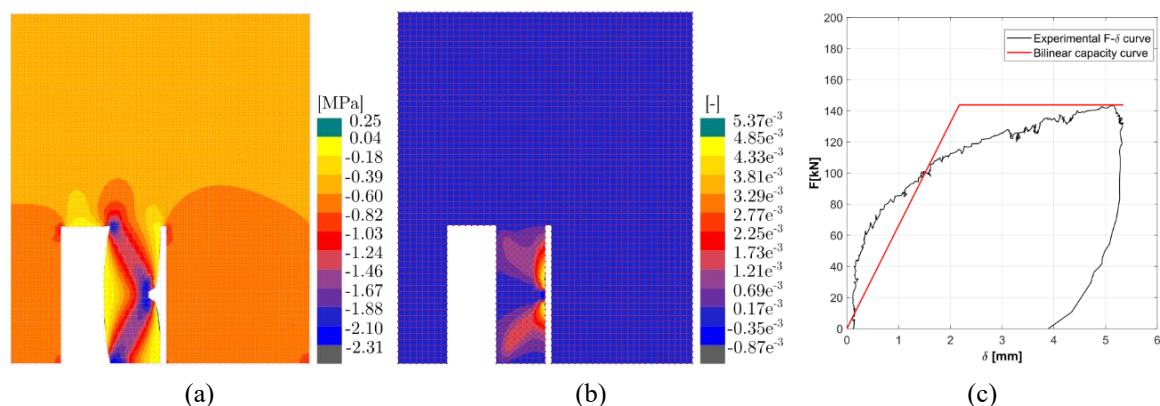

Fig. 4 Minimum principal stress (a), Anelastic tensile strain MMLM E^a (b), experimental load displacement curve (c)

The mesh of the described model uses four-node plane stress (PS) elements with a 9-centimeter length side for a total of 2684 elements and 2839 vertices. To reproduce the real setting of the panel from the viewpoint of constraints the base is considered perfectly fixed and horizontal rollers are placed on the left side of the elastic frame to contemplate the presence of the orthogonal wall.

Nonlinear static analyses are performed by prescribing an increasing horizontal displacement in half the height of the masonry panel while keeping the vertical load constant.

Fig. 4(a) displays representative results of the analysis in terms of minimum principal stress distribution for the ultimate behavior of the investigated masonry panel simulated with mean values of the mechanical input parameters. Further, the damage caused by the tensile stress, accounted in a smeared damage approach through the norm of the inelastic tensile strain E^a , alias a measure of the damage on the entire panel, is displayed in Fig. 4(b). The experiential load-displacement curve and the derived bilinear capacity curve are plotted in Fig. 4(c).

The obtained concentration of negative stresses determining a highly compressed diagonal band is relevant and is in good agreement with the experimental damaged areas. The occurrence of two diagonal struts symmetrical to a horizontal line in half the height of the panel, corresponding to the application point of the horizontal increasing load, is pointed out also by the distribution of the higher values of the inelastic tensile damage.

3.2 Probabilistic description of input parameters and gPCE-based surrogate model generation

The input parameters for the definition of the Modified Masonry-like Material are the compressive resistance f_m , the tensile resistance f_t , the cohesion f_{v0} , the frictional angle μ , the elastic Young's modulus E , and the Poisson's ratio ν .

Deriving these values is not effortless, because it would require the performing of extensive destructive and semi-destructive experimental campaigns, which contrast with the aim of safeguarding the integrity of historical masonry structures (Croce *et al.* 2021a). Therefore, the principal mechanical parameters have been collected into different masonry types defined based on proper statistical elaborations of an adequate number of tested samples.

The typical range of values of reference parameters of some recurrent masonry typologies can

be found in the Guidelines for the application of the Italian Building Code (Italian Ministry of Infrastructures and Transportation 2018) and its specifications (Italian Public Works Council 2019).

In this paper, the choice of the reference masonry typology, namely the so-called “partially dressed stone” of the Guidelines, was guided by the results in terms of f_m and E , obtained from experimental in-situ campaigns (Beconcini *et al.* 2021).

The statistical data to describe its mechanical properties required as inputs for the numerical model with the Modified Masonry-like Material are those of “Class II” (Croce *et al.* 2021b). This is a medium-quality masonry chosen because the mean value of the distribution of f_m and E is similar to the values obtained through the in-situ tests of the case study panel.

The *pdfs* and statistical data identifying the distribution of the independent random variables are reported in Table 1, along with the corresponding polynomial for gPCE from the Askey scheme (Marzouk *et al.* 2007).

Masonry mechanical parameters are generally linked to the quality and type of masonry. Nevertheless, the relation among the different mechanical properties of masonry is by no means easy to obtain. There are several elements, such as the quality and dimensions of single components, i.e., adobe block and mortar joints, which play a role in determining the mechanical properties. Given the extreme variability of masonry typologies, the eventual correlation among mechanical properties, if any, is closely case-related, and generalizations are hardly doable. In this sense, many studies have sought to find relations between the various mechanical properties of masonry.

One of the few renowned relations that hold between the mechanical properties of masonry is

$$f_t = 1.5 \cdot \tau_0 \quad (7)$$

from (Turnsek and Cacovic 1971), where the tensile stress f_t is equal to the shear strength τ_0 amplified by 1.5 times.

Apart from that, there are not many other proven correlations that hold among mechanical properties of masonry, despite constant research in this direction.

For example, (Sánchez 2022) has recently tried to derive a correlation between the mechanical properties of masonry considering an extensive review of several experimental studies from many countries over the last 15 years of research. However, it revealed that it is not straightforward to obtain correlation even for laboratory specimens, let alone on real case studies such as the one at hand.

In light of this, and also considering that for the relation (7) one of the two mechanical properties (τ_0) does not belong to the input parameters of the Modified Masonry-like Material, the authors deemed it licit to consider the mechanical properties of masonry as independent random variables.

As for the assumed values, the mean and the standard deviation of f_m and E directly derive from “Class II”, statistical data defining the distribution of f_t and f_{v0} comes from data available for “partially dressed stone” in the Guidelines for the application of the Italian Building Code; μ and ν are instead based on the expert judgments and are values generally adopted for masonry (Bracchi *et al.* 2016). In fact, in Bracchi *et al.* (2016) the lower limit of ν is 0.15, and the upper one is set to a value roughly around 0.33, as defined in (Italian Public Works Council 2019). Moreover, extensive experimental campaigns (Bosiljkov *et al.* 2005, Tomažević 2009) show that the range of Poisson’s ratio is wide, being also dependent on the load level.

Even if it can reach up also values of 0.5 for very anisotropic masonry (Bracchi *et al.* 2016)

Table 1 Parameters, distributions, and orthogonal polynomials

Parameter	Distribution	Statistical data [MPa]	Polynomial
f_m	log-normal	$\sigma=1.91, \mu=0.23$	Hermite
f_t	log-normal	$\sigma=0.0645, \mu=0.012$	Hermite
f_{v0}	uniform	min=0.3, max=0.6	Legendre
μ	uniform	min=0.2, max=1.0	Legendre
E	log-normal	$\sigma=1384, \mu=290.64$	Hermite
ν	uniform	min=0.15, max=0.25	Legendre

most values available in the scientific literature (Lourenço *et al.* 1998, Lucchesi *et al.* 2018b) (for both $\nu=0.18$), falls within the range chosen for the uniform distribution of ν in this paper (0.15-0.25).

On the other hand, μ can be inferred from (Lucchesi *et al.* 2008). In the simulations of masonry panels with the Modified Masonry-like Material in MADY code μ varies over the range of $0 \leq \mu \leq 1.73$, corresponding to a frictional angle between 0° - 60° . This range can be narrowed down considering that μ generally falls in an interval from 0.4 (dry stone masonry) to 0.2 (rubble masonry) (Angelillo *et al.* 2014). Further, also values of the frictional angle equal to 30° - 40° (i.e., $0.36 \leq \mu \leq 0.34$) are still realistic (Sarhosis *et al.* 2015). Therefore, μ can take a value between 0.2 and 1.0 in the chosen uniform distribution.

Finally, f_t is indirectly deduced from the Italian Public Works Council (2019), there being here only the range of values of τ_0 , the shear strength. f_t can be easily obtained with the following simple relation $f_t = 1.5 \cdot \tau_0$ (Turnsek and Cacovic 1971). The Italian Public Works Council (2019) does not include any value of f_{v0} , being the shear-failure unlikely to occur for the masonry typology at hand. For this reason, the minimum takes a high value so as not to make τ_0 the parameter responsible of the panel failure.

In this paper, the generation of the proxy model is carried out by adopting a three-degree gPC expansion after assessing that the maximum difference between the surrogate surface and the solution of the FE model is not relevant from an engineering point of view. Fig. 5 proves that a

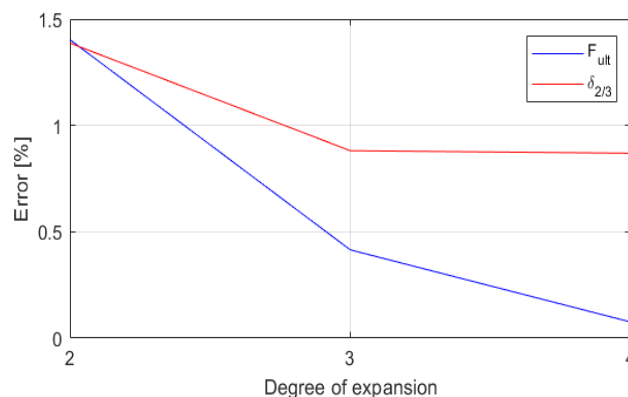

Fig. 5 Error of the two measurements (displacement at 2/3 of the ultimate load ($\delta_{2/3}$) and ultimate load (F_{ult})) simulated with the surrogate model as a function of the degree of the expansion with respect to the FE solution

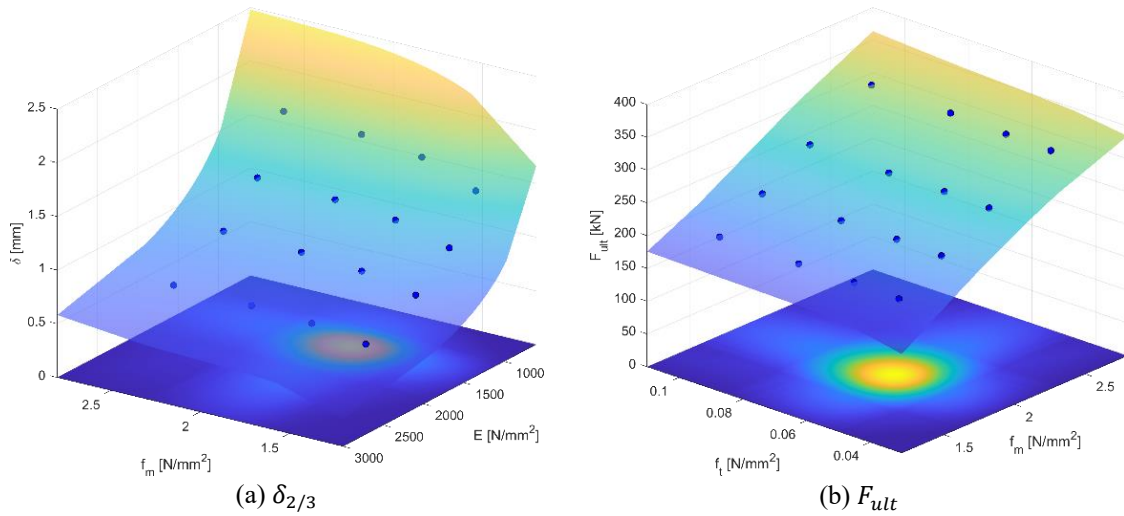

Fig. 6 Response surfaces for displacement $\delta_{2/3}$ (a) and ultimate load F_{ult} (b)

Table 2 Sobol Indices of mechanical input parameters

Parameter	$SI_{s,1}(F_{ult})$	$SI_{s,2}(\delta_{2/3})$
f_m	0.820	0.275
f_t	0.002	=0.000
f_{v0}	0.074	0.007
μ	0.104	0.01
E	=0.000	0.706
ν	=0.000	0.002

three-degree expansion is adequate to set the error between the deterministic FE model and the surrogate one below to the 1% for both the displacement at 2/3 ($\delta_{2/3}$) of the ultimate load, and the ultimate load (F_{ult}).

In Fig. 6, representative response surfaces are displayed. The first one shows the displacement measured at 2/3 of the ultimate load, $\delta_{2/3}$, considering the variations of f_m and E (Fig. 6(a)) while the other mechanical parameters take the following values: $f_t = 0.041$ MPa, $f_{v0} = 0.321$ MPa, $\mu = 0.255$, $\nu = 0.157$. The second surface for the ultimate load F_{ult} (Fig. 6(b)) is obtained by varying f_m and f_t , and assuming the other inputs as follows: $f_{v0} = 0.501$ MPa, $\mu = 0.464$, $\nu = 0.157$, $E = 834$ MPa.

3.3 Results of the Sensitivity Analysis (SA)

The sensitivities of two quantities of interest, namely the horizontal ultimate load F_{ult} ($SI_{s,1}$) and horizontal displacement $\delta_{2/3}$ ($SI_{s,2}$), were analyzed with the help of the Sobol sensitivity Indices, as reported in Table 2.

In the evaluation of the horizontal load the panel is subjected to, f_m plays a key role with a SI equal to 0.820, which is in line with common knowledge alleging the increasing of shear resistance with growing values of the compressive load. Besides, the shear parameters μ and f_{v0} are the

second and third most influential mechanical parameter with a SI equal to 0.104 and 0.074, as expected in a shear compression test.

On the other hand, regarding the SA involving the evaluation of the influence of chosen input variables on the horizontal displacement a different impact of the different mechanical properties can be observed. Particularly, E reports the highest SI with a value of 0.706, followed by f_m with 0.275, and f_{v0} with 0.007. The remaining variables have nearly no influence on the horizontal displacement.

3.4 Results of the Bayesian updating

Within the probabilistic framework for the assessment and calibration of masonry material described in Section 2.2, the last step is the calibration of the numerical model.

In the case at hand, the Bayesian updating of the pdfs of mechanical input parameters, has been performed by considering two different measurements obtained from in-situ experimental tests, namely the ultimate load $F_{ult} = 208.6$ kN, and the displacement $\delta_{2/3} = 0.65$ mm. The inverse problem is solved by applying the Markov Chain Monte Carlo method and the results are shown in Fig. 7.

On the whole, the result of the updating shows that the *pdfs* of the various input parameters change in shape in different ways.

Particularly, those parameters to which the model presents higher sensitivity, i.e., f_m and E , correspond to the ones whose posteriors differ more significantly with respect to priors, which is in line with what can be inferred from the SA in terms of SI_s . The posterior distribution of f_m is characterized by a reduced coefficient of variation with respect to a priori one, with the mean passing from 1.91 MPa to 1.60 MPa. Similarly, the variability of the updated distribution of E decreases and the mean modifies its value from 1384 MPa to 1522 MPa.

Moreover, for the mechanical properties characterized by low SI_s (but different from zero), as in the case of the shear parameters f_{v0} and μ , the updating is helpful to derive *pdfs* capable of better describing the probability distribution.

On the contrary, the parameters with SI_s close to zero with respect to both used measurements, namely f_t , and ν , do not take much benefit from the updating because their relevance for the measured response is about nothing.

4. Conclusions

A probabilistic framework for uncertainty quantification computations and stochastic identification of masonry parameters in 2D finite elements continuum models is presented. The Modified Masonry-like Material (MMLM) is investigated with the aim to reproduce the experimental behavior of a masonry wall under horizontal loads.

The proposed methodology allows one to clearly identify the relevant input parameters in the constitutive law that require adequate calibration to achieve a good agreement between the predicted and experimental response. In particular, with reference to a relevant case study, the results of SA highlight that the most relevant parameters in reproducing the shear behavior of such masonry walls are the compressive strength and the elastic modulus. Finally, these uncertain parameters are updated based on the outcomes of the in-situ shear-compression test in terms of ultimate load and elastic displacement.

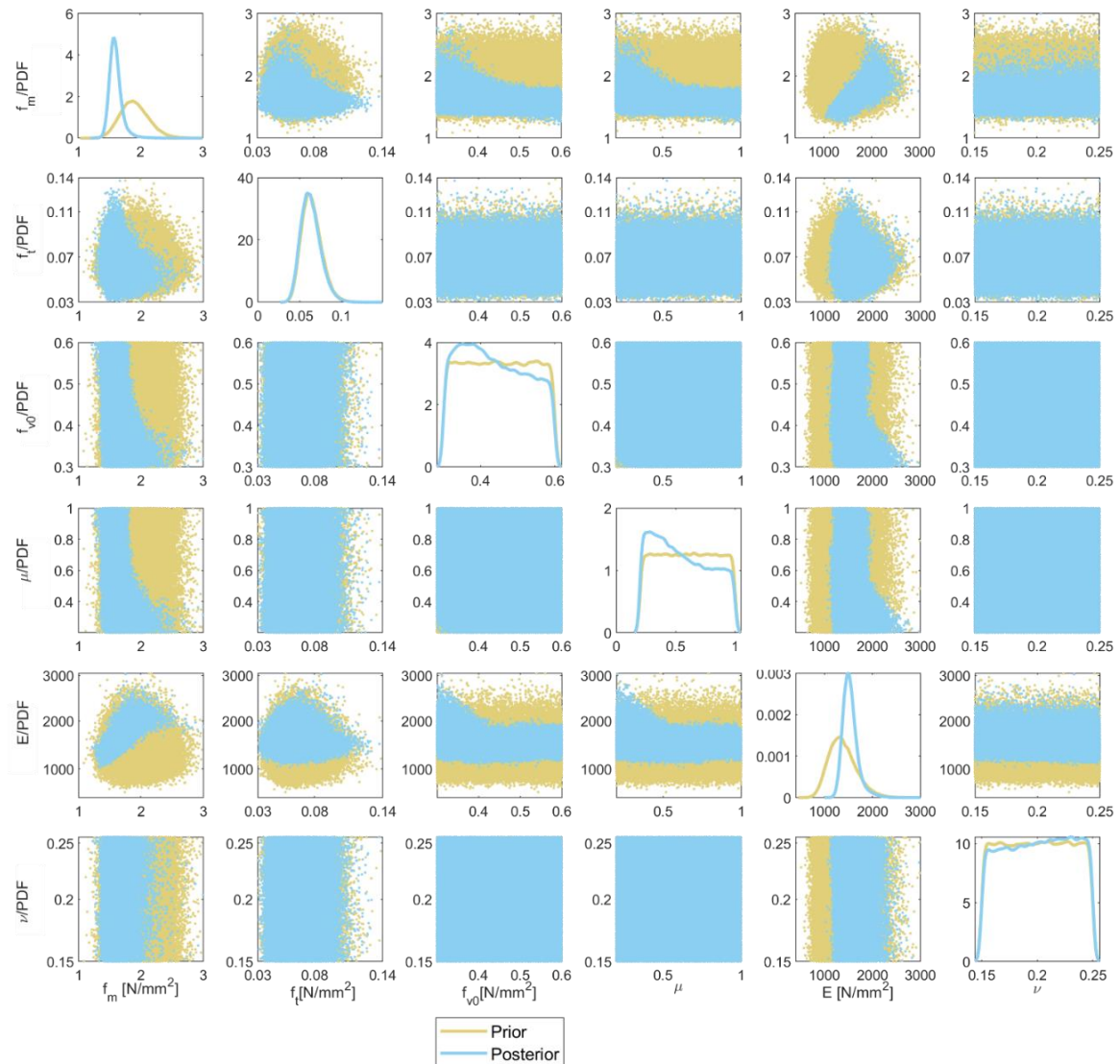

Fig. 7 Results of Bayesian updating, prior and posterior distribution of the input parameters in a pairs scatter plot

References

- Angelillo, M., Lourenço, P.B. and Milani, G. (2014), “Masonry behaviour and modelling”, *Mech. Masonry Struct.*, 1-26. https://doi.org/10.1007/978-3-7091-1774-3_1.
- Asteris, P.G. and Plevis, V. (2015), *Handbook of Research on Seismic Assessment and Rehabilitation of Historic Structures*, IGI Global.
- Beconcini, M.L., Croce, P., Formichi, P., Landi, F. and Puccini, B. (2021), “Experimental evaluation of shear behavior of stone masonry wall”, *Mater.*, **14**(9), 2313. <https://doi.org/10.3390/ma14092313>.
- Berto, L., Saetta, A., Scotta, R. and Vitaliani, R. (2002), “An orthotropic damage model for masonry structures”, *Int. . Numer. Meth. Eng.*, **55**(2), 127-157. <https://doi.org/10.1002/nme.495>.

- Bosiljkov, V.Z., Totoev, Y.Z. and Nichols, J.M. (2005), "Shear modulus and stiffness of brickwork masonry: An experimental perspective", *Struct. Eng. Mech.*, **20**(1), 21-43. <https://doi.org/10.12989/sem.2005.20.1.021>.
- Bracchi, S., Rota, M., Magenes, G. and Penna, A. (2016), "Seismic assessment of masonry buildings accounting for limited knowledge on materials by Bayesian updating", *Bull. Earthq. Eng.*, **14**(8), 2273-2297. <https://doi.org/10.1007/s10518-016-9905-8>.
- Clemente, R. (2006), "Structural analysis of historical buildings by localized cracking models", PhD Thesis, Universitat Politècnica de Catalunya, Barcelona, Spain.
- Clemente, R., Roca, P. and Cervera, M. (2006), "Damage model with crack localization-application to historical buildings", *Structural Analysis of Historical Constructions*, New Delhi, India.
- Como, M. and Grimaldi, A. (1985), "A unilateral model for the limit analysis of masonry walls", *Unilateral Problems in Structural Analysis: Proceedings of the Second Meeting on Unilateral Problems in Structural Analysis*, Ravello, September.
- Croce, P., Beconcini, M.L., Formichi, P., Landi, F., Puccini, B. and Zotti, V. (2021a), "Evaluation of partial safety factors for the structural assessment of existings masonry buildings", *18th International Probabilistic Workshop*, **153**, 341-352. https://doi.org/10.1007/978-3-030-73616-3_25.
- Croce, P., Beconcini, M.L., Formichi, P., Landi, F., Puccini, B. and Zotti, V. (2021b), "Bayesian methodology for probabilistic description of mechanical parameters of masonry walls", *ASCE-ASME J. Risk Uncertain. Eng. Syst., Part A: Civil Eng.*, **7**(2), 04021008. <https://doi.org/10.1061/AJRUA6.0001110>.
- Del Piero, G. (1989), "Constitutive equation and compatibility of the external loads for linear elastic masonry-like materials", *Meccanica*, **24**(3), 150-162. <https://doi.org/10.1007/BF01559418>.
- Di Pasquale, S. (1982), "Questioni di meccanica dei solidi non reagenti a trazione", *Atti VI Convegno Nazionale AIMETA*, Genova, 7-9.
- Di Pasquale, S. (1984), "Statica dei solidi murari: Teoria ed esperienze", Dipartimento di Costruzioni, Università di Firenze.
- Dragon, A. and Mróz, Z. (1979), "A continuum model for plastic-brittle behaviour of rock and concrete", *Int. J. Eng. Sci.*, **17**(2), 121-137. [https://doi.org/10.1016/0020-7225\(79\)90058-2](https://doi.org/10.1016/0020-7225(79)90058-2).
- Formisano, A., Sorrentino, L. and Zucconi, M. (2023), "Editorial of the special issue "Seismic vulnerability and strengthening of unreinforced masonry buildings"", *Geosci.*, **13**(3), 62. <https://doi.org/10.3390/geosciences13030062>.
- Ghanem, R. and Red-Horse, J. (2017), *Polynomial Chaos: Modeling, Estimation, and Approximation*, Eds. R. Ghanem, D. Higdon, and H. Owhadi, Handbook of Uncertainty Quantification, Springer International Publishing.
- Hillerborg, A., Modéer, M. and Petersson, P.E. (1976), "Analysis of crack formation and crack growth in concrete by means of fracture mechanics and finite elements", *Cement Concrete Res.*, **6**(6), 773-781. [https://doi.org/10.1016/0008-8846\(76\)90007-7](https://doi.org/10.1016/0008-8846(76)90007-7).
- Italian Ministry of Infrastructures and Transportation (2018), NTC 2018-Italian Building Code.
- Italian Public Works Council (2019), "Memorandum for application of italian building code, N. 7", *Italian Official Journal*, Istituto Poligrafico e Zecca dello Stato, Rome, Italy. (in Italian)
- Kachanov, L.M. (2004), *Fundamentals of the Theory of Plasticity*, Courier Corporation.
- Krentowski, J.R., Knyziak, P., Pawłowicz, J.A. and Gavardashvili, G. (2023), "Historical masonry buildings' condition assessment by non-destructive and destructive testing", *Eng. Fail. Anal.*, **146**, 107122. <https://doi.org/10.1016/j.engfailanal.2023.107122>.
- Landi, F., Marsili, F., Friedman, N. and Croce, P. (2021), "gPCE-Based stochastic inverse methods: A benchmark study from a civil engineer's perspective", *Infrastruct.*, **6**(11), 158. <https://doi.org/10.3390/infrastructures6110158>.
- Lee, J. and Fenves, G.L. (1998), "Plastic-damage model for cyclic loading of concrete structures", *J. Eng. Mech.*, **124**(8), 892-900. [https://doi.org/10.1061/\(ASCE\)0733-9399\(1998\)124:8\(892\)](https://doi.org/10.1061/(ASCE)0733-9399(1998)124:8(892)).
- Løland, K.E. (1980), "Continuous damage model for load-response estimation of concrete", *Cement Concrete Res.*, **10**(3), 395-402. [https://doi.org/10.1016/0008-8846\(80\)90115-5](https://doi.org/10.1016/0008-8846(80)90115-5).
- Lourenço, P.B., Rots, J.G. and Blaauwendraad, J. (1998), "Continuum model for masonry: Parameter

- estimation and validation”, *J. Struct. Eng.*, **124**(6), 642-652. [https://doi.org/10.1061/\(ASCE\)0733-9445\(1998\)124:6\(642\)](https://doi.org/10.1061/(ASCE)0733-9445(1998)124:6(642)).
- Lublinter, J., Oliver, J., Oller, S. and Oñate, E. (1989), “A plastic-damage model for concrete”, *Int. J. Solid. Struct.*, **25**(3), 299-326. [https://doi.org/10.1016/0020-7683\(89\)90050-4](https://doi.org/10.1016/0020-7683(89)90050-4).
- Lucchesi, M., Padovani, C., Pasquinelli, G. and Zani, N. (2008), *Masonry Constructions: Mechanical Models and Numerical Applications*, Springer Science & Business Media.
- Lucchesi, M., Pintucchi, B. and Zani, N. (2017), “Modelling masonry structures through the MADY code”, *Proceedings of the 2nd International Conference on Recent Advances in Nonlinear Models-Design and Rehabilitation of Structures*, 10.
- Lucchesi, M., Pintucchi, B. and Zani, N. (2018a), “Bounded shear stress in masonry-like bodies”, *Meccanica*, **53**(7), 1777-1791. <https://doi.org/10.1007/s11012-017-0719-9>.
- Lucchesi, M., Pintucchi, B. and Zani, N. (2018b), “Masonry-like material with bounded shear stress”, *Eur. J. Mech.-A/Solid.*, **72**, 329-340. <https://doi.org/10.1016/j.euromechsol.2018.05.001>.
- Marzouk, Y.M., Najm, H.N. and Rahn, L.A. (2007), “Stochastic spectral methods for efficient Bayesian solution of inverse problems”, *J. Comput. Phys.*, **224**(2), 560-586. <https://doi.org/10.1016/j.jcp.2006.10.010>.
- Matthies, H.G., Zander, E., Rosić, B.V. and Litvinenko, A. (2016), “Parameter estimation via conditional expectation: A Bayesian inversion”, *Adv. Model. Simul. Eng. Sci.*, **3**(1), 24. <https://doi.org/10.1186/s40323-016-0075-7>.
- Matthies, H.G., Zander, E., Rosić, B.V., Litvinenko, A. and Pajonk, O. (2016), “Inverse problems in a Bayesian setting”, Ed. A. Ibrahimbegovic, *Computational Methods for Solids and Fluids*, **41**, 245-286. https://doi.org/10.1007/978-3-319-27996-1_10.
- Mazars, J. (1984), “Application de la mécanique de l’endommagement au comportement non lineaire et a rupture du beton de structure”, PhD Thesis, Université Pierre et Marie Curie-CNRS.
- Papa, E. (1996), “A unilateral damage model for masonry based on a homogenisation procedure”, *Mech. Cohes.-Frict. Mater.*, **1**(4), 349-366. [https://doi.org/10.1002/\(SICI\)1099-1484\(199610\)1:4<349::AID-CFM18>3.0.CO;2-M](https://doi.org/10.1002/(SICI)1099-1484(199610)1:4<349::AID-CFM18>3.0.CO;2-M).
- Roca, P., Cervera, M., Gariup, G. and Pela’, L. (2010), “Structural analysis of masonry historical constructions. Classical and advanced approaches”, *Arch. Comput. Meth. Eng.*, **17**(3), 299-325. <https://doi.org/10.1007/s11831-010-9046-1>.
- Romano, G. and Romano, M. (1985), “Elastostatics of structures with unilateral conditions on stress and displacement fields”, *Unilateral Problems in Structural Analysis: Proceedings of the Second Meeting on Unilateral Problems in Structural Analysis*, Ravello, September.
- Rosić, B.V., Kučerová, A., Sýkora, J., Pajonk, O., Litvinenko, A. and Matthies, H.G. (2013), “Parameter identification in a probabilistic setting”, *Eng. Struct.*, **50**, 179-196. <https://doi.org/10.1016/j.engstruct.2012.12.029>.
- Saloustros, S., Pelà, L. and Cervera, M. (2015), “A crack-tracking technique for localized cohesive-frictional damage”, *Eng. Fract. Mech.*, **150**, 96-114. <https://doi.org/10.1016/j.engfracmech.2015.10.039>.
- Saloustros, S., Pelà, L., Cervera, M. and Roca, P. (2018), “An enhanced finite element macro-model for the realistic simulation of localized cracks in masonry structures: A large-scale application”, *Int. J. Arch. Heritage*, **12**(3), 432-447. <https://doi.org/10.1080/15583058.2017.1323245>.
- Saltelli, A. (2008), *Global Sensitivity Analysis: The Primer*, John Wiley.
- Saltelli, A. and Sobol’, I.M. (1995), “About the use of rank transformation in sensitivity analysis of model output”, *Reliab. Eng. Syst. Saf.*, **50**(3), 225-239. [https://doi.org/10.1016/0951-8320\(95\)00099-2](https://doi.org/10.1016/0951-8320(95)00099-2).
- Sánchez, A., Varum, H., Martins, T. and Fernández, J. (2022), “Mechanical properties of adobe masonry for the rehabilitation of buildings”, *Constr. Build. Mater.*, **333**, 127330. <https://doi.org/10.1016/j.conbuildmat.2022.127330>.
- Sarhosis, V., Garrity, S.W. and Sheng, Y. (2015), “Influence of brick-mortar interface on the mechanical behaviour of low bond strength masonry brickwork lintels”, *Eng. Struct.*, **88**, 1-11. <https://doi.org/10.1016/j.engstruct.2014.12.014>.
- Sobol, I.M. (2001), “Global sensitivity indices for nonlinear mathematical models and their Monte Carlo

- estimates”, *Math. Comput. Simul.*, **55**(1-3), 271-280. [https://doi.org/10.1016/s0378-4754\(00\)00270-6](https://doi.org/10.1016/s0378-4754(00)00270-6).
- Sudret, B. (2008), “Global sensitivity analysis using polynomial chaos expansions”, *Reliab. Eng. Syst. Saf.*, **93**(7), 964-979. <https://doi.org/10.1016/j.ress.2007.04.002>.
- Sudret, B. (2015), *Polynomial Chaos Expansions and Stochastic Finite-Element Methods*, In *Risk and Reliability in Geotechnical Engineering*, CRC Press.
- Sudret, B. and Mai, C.V. (2015), “Computing derivative-based global sensitivity measures using polynomial chaos expansions”, *Reliab. Eng. Syst. Saf.*, **134**, 241-250. <https://doi.org/10.1016/j.ress.2014.07.009>.
- Sykora, M. and Holický, M. (2010), “Probabilistic model for masonry strength of existing structures”, *Eng. Mech.*, **17**(1), 61-70.
- Sykora, M., Cejka, T., Holický, M. and Witzany, J. (2013), “Probabilistic model for compressive strength of historic masonry”, *Safety, Reliability and Risk Analysis*, CRC Press.
- Tarantola, A. (2005), *Inverse Problem Theory and Methods for Model Parameter Estimation*, SIAM.
- Tierney, L. (1994), “Markov chains for exploring posterior distributions”, *Ann. Stat.*, **22**(4), 1701-1728. <https://doi.org/10.1214/aos/1176325750>.
- Tomažević, M. (2009), “Shear resistance of masonry walls and Eurocode 6: Shear versus tensile strength of masonry”, *Mater. Struct.*, **42**(7), 889-907. <https://doi.org/10.1617/s11527-008-9430-6>.
- Turnšek, V. and Cacovic, F. (1971), “Some experimental results on the strength of brick masonry walls”, *Proceedings of the 2nd International Brick Masonry Conference*, British Ceramic Research Association, Stoke-on-Trent, UK.
- Wei, D.L., Cui, Z.S. and Chen, J. (2008), “Uncertainty quantification using polynomial chaos expansion with points of monomial cubature rules”, *Comput. Struct.*, **86**(23-24), 2102-2108. <https://doi.org/10.1016/j.compstruc.2008.07.001>.
- Wiener, N. (1938), “The homogeneous chaos”, *Am. J. Math.*, **60**(4), 897. <https://doi.org/10.2307/2371268>.
- Xiu, D. (2010), *Numerical Methods for Stochastic Computations: A Spectral Method Approach*, Princeton University Press.
- Xiu, D. and Karniadakis, G.E. (2002), “The Wiener-Askey polynomial chaos for stochastic differential equations”, *SIAM J. Scientif. Comput.*, **24**(2), 619-644. <https://doi.org/10.1137/s1064827501387826>.