

Influence of porosity on the behavior of cement orthopaedic of total hip prosthesis

Benouis Ali*, Serier Boualem and Benbarek Smail

Mechanics and Physics of Materials Laboratory, Djillali Liabes University of Sidi Bel-Abbes, BP89 cité Larbi Ben M'hidi, Sidi Bel-Abbes, Algeria

(Received September 27, 2014, Revised March 19, 2015, Accepted March 19, 2015)

Abstract. This paper presents three-dimensional finite element method analyses of the distribution of equivalent stress of Von Mises. Induced around a cavity located in the bone cement polymethylmethacrylate (PMMA). The presence and effect of its position in the cement was demonstrated, thus on the stress level and distribution. The porosity interaction depending on their positions, and their orientations on the interdistances their mechanical behaviour of bone cement effects were analysed. The obtained results show that micro-porosity located in the proximal and distal zone of the prosthesis is subject to higher stress field. We show that the breaking strain of the cement is largely taken when the cement, containing the porosities very close adjacent to each other.

Keywords: bone cement; porosity; fracture mechanics; stress concentration; finite element method

1. Introduction

PMMA has been the standard product in the orthopaedic industry for decades. The formation and development of micro-voids, usually plays a dominant role in the damage and fracture of bone cement. The major problem associated with the presence of flaws due to pores and additives is that when a critical flaw size is achieved, the flaws act as sites of stress concentration, leading to weakening of the cement. Several studies on the analysis of the stress distribution in the bone cement have been carried out. Benbarek *et al.* (2007), have analysed numerically by the finite element method the effect of the orientation of the axis of the implant relative to that of the cup on the level and the distribution of stresses in the bone cement containing a micro-cavity and therefore the stress intensity factor in head crack from this cavity.

In another study Bachir Bouiadjra *et al.* (2007) studied the behaviour of cement out of the acetabulum by analysing the stress intensity factor. They show that the failure mode depends on the position of the crack. Benbarek *et al.* (2007) showed that the stress intensity factor mode in a two mode depends not only on the orientation of the crack initiated in the cement but also that of the implant relative to the cup. Serier *et al.* (2009) have looked at the effect of the position of the crack initiated in the cement according to the position of the implant relative to the cup on the stress intensity factor. Bouziane *et al.* (2009) analysed by the finite element method, and showed

*Corresponding author, MSc., E-mail: aly_ouis@hotmail.fr

Table 1 Materials properties (Lewis *et al.* 1997)

	Young's Modulus (MPa)	Poisson's ratio
Implant Ti-6Al-4V	110.000	0.30
Cortical bone	$E_x=E_y=11.500, E_z=17.000$ $G_{xy}=3600, G_{xz}=G_{yz}=3300$	$\nu_{xz}=\nu_{yz}=0.31$ $\nu_{xy}=0.51$
Cement (PMMA)	2700	0.35

that the presence of cement in the cavity where bone fragment is a source of stress concentration.

This study presents three-dimensional finite element method analyses of the amplitude of the induced stresses on the bone cement around a cavity and the effect of interaction with cement-implant interface, with another cavity on the intensity and the distribution of stresses in the material and the effect of the distance of cavity-cavity. The obtained results allow an explanation of the interconnection cavity through cracks observed experimentally by J. Hertzler

Zouambi *et al.* (2013) have studied the behavior of bone cement into the acetabulum, and the effect of the presence of defects and their interactions; they show an increase in the defect density results in very important stress intensity.

Waanders Daan *et al.* (2012) studied the micromechanical behavior of cement near the cement-bone interface on damage of PTH.

2. Presentation of the analysed model

This analysis uses the model of the femoral implant in three dimensions. This modeling was done using the software of finite element calculation: Abaqus 9.1 (2004). The cylindrical geometry of a femoral implant related bone via the bone cement is shown in Fig. 1. This model was developed by Huiskes (1980).

In its static analysis, the author considers the transverse load applied equally to 600 N. It shows that the effect of axial compression is very small (Nuño *et al.* 2002).

The analysed cavities are localized in the region of the cement more strongly mechanically stressed. That is to say the part of the cement, which are under high stress intensity. This is the part where the risk of rupture of the cement, and thus loosening is the most probable.

By its high geometrical symmetry of a half model of the structure comprised of more elements 100000 was analysed. The mechanical properties of the constituents of the total hip prosthesis, which is assumed elastic behaviour, are shown in Table 1.

3. Results

3.1 Distribution of the stresses in the cement healthy

For a clearer illustration of the effect of the presence of a cavity in the bone cement and the intensity distribution of the equivalent stress being induced in the Von component subjected to mechanical efforts, we have shown in Fig. 1 the variation of this constraint in both proximal and distal portions of healthy cement, That is to say containing no defects (cavities). This figure shows that the implant cement interface most highly concentrated stresses.

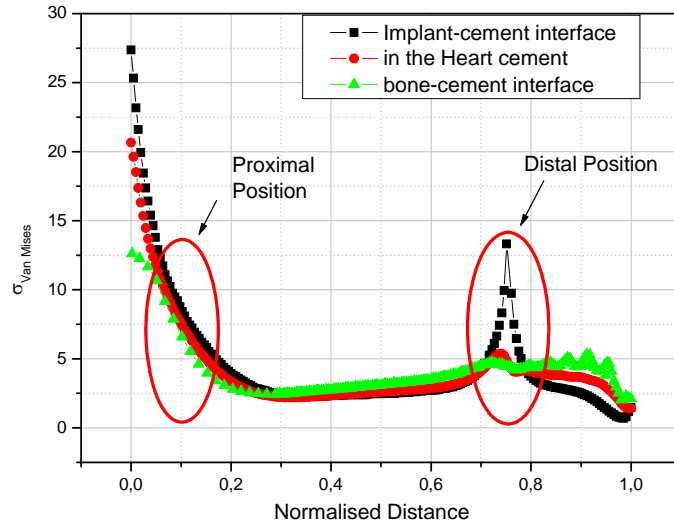

Fig. 1 Variation induced of Von Mises stress in the proximal and distal areas of the sound in the upper portion cement according to the load applied to the implant

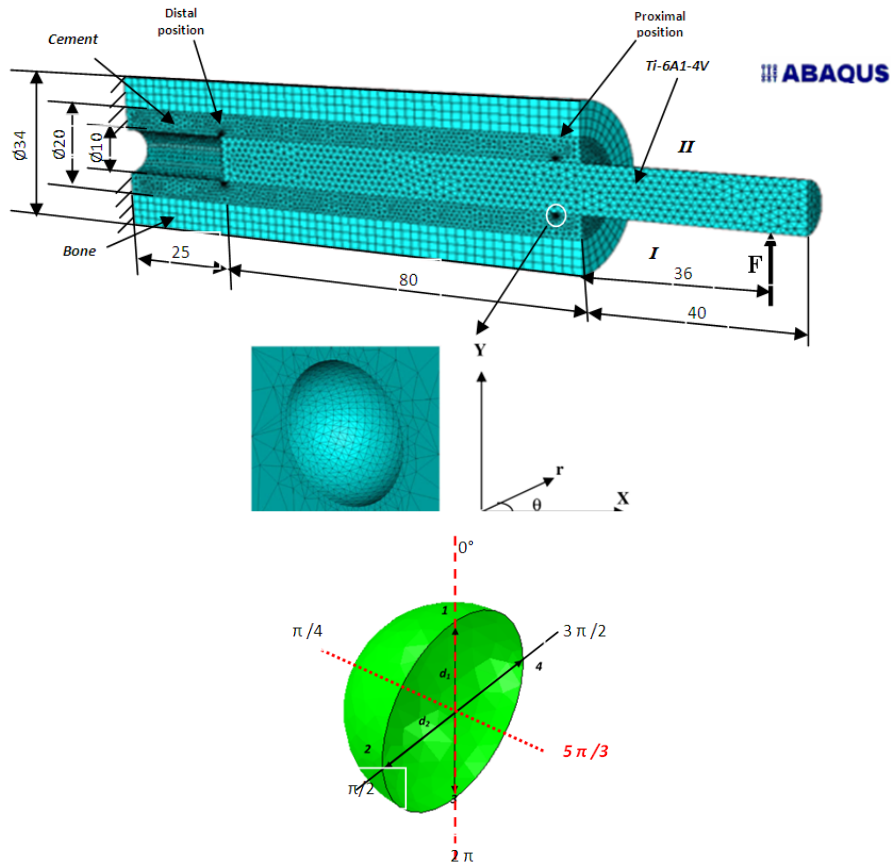

Fig. 2 Position and size of the cavity in the cement and mesh used around this defect

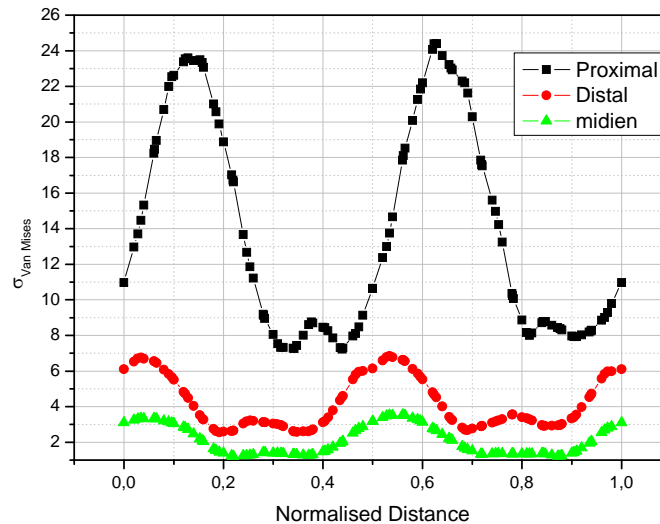

Fig. 3 The distribution of the equivalent stress of Von Mises induced in cement in its proximal part around the cavity located in the heart of this component

In fact, their intensity at this interface is significantly higher than the heart of the cement and its interface with the bone. In the very near vicinity of the interface with the implant, in its proximal part, the cement is highly mechanically biased.

This high level of stress is due to the interaction interface (cement-implant) cement. It is in this area of high stress of the cement will be located where the cavities in order analyse their effect on the mechanical behaviour.

3.2 Effect of the position of cavity

The effect of two positions of the bone cement in the cavity at the level and the distribution of von Mises equivalent stress induced by mechanical stress was analysed (Fig. 3).

3.3 Cavity located in the heart of cement

The cavity is placed in a first time, the heart of the bone cement in the proximal, middle and distal away from the interface with the implant. The effect of the cavity at the level and the distribution of the equivalent Von Mises stress in these three zones are illustrated in Fig. 3. This figure shows that the cement is most loaded in its proximal part and that these stresses are on a level more than that induced by a cavity located close to the interface (Figs. 4 and 5). The effect of this position on the amplitude of the equivalent stress appears clearly on the distal part of the cement (Fig. 5), and this constraint has almost doubled in intensity.

3.4 Cavity localized near the interface with the implant

The cavity is located in the portion of the cement being under very strong tensile stresses (portion near the interface with the implant). This location used to analyse the effects of cement-

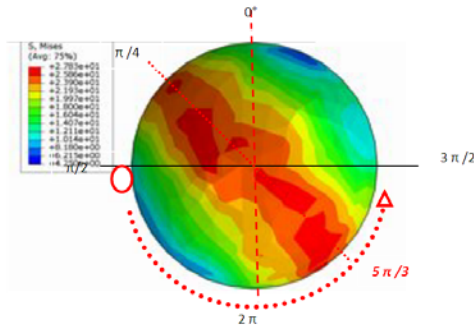

Fig. 4 Distribution of von Mises equivalent stresses in the cement at the interface with the cavity

interface interaction. The level of the equivalent Von Mises stress around the cavity was analysed in the cement in its proximal and distal portions.

In Fig. 5 are shown the level and distribution of von Mises equivalent stresses in the cement at the interface with the cavity. It shows that the distribution of stresses around the fault is not homogeneous. They are favourably oriented at an angle of approximately $\pi/4$ - $3\pi/2$ from the center of gravity of the cavity.

Fig. 7 is illustrated the amplitude of the stress induced in the bone cement as a result of mechanical stresses applied to the implant. This figure clearly shows that the cement is strongly biased in the proximal portion and this biasing is especially higher than the mechanical load is largest. It is in the distal portion or the effect of the position of the cavity is greater. In this part of the cement induced stress has almost doubled in intensity.

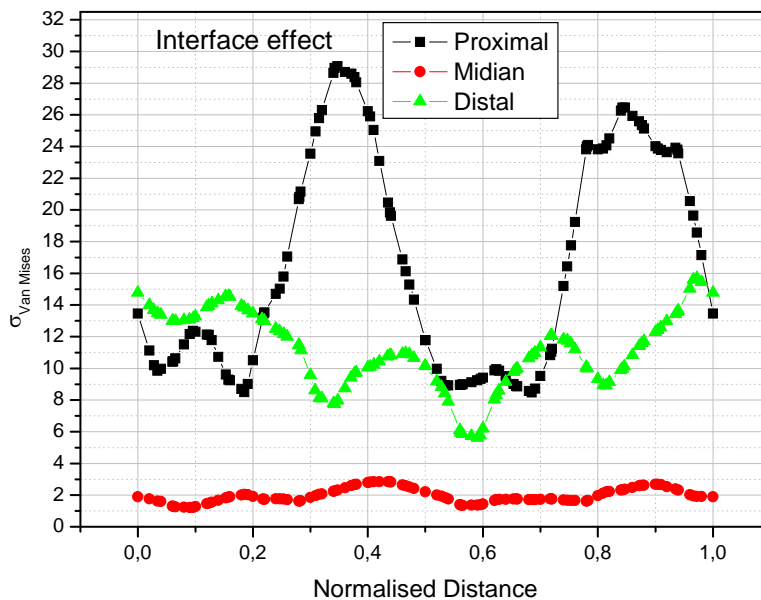

Fig. 5 Equivalent stress distribution of Von Mises induced in the cement around the component in the cavity located near the interface with the implant

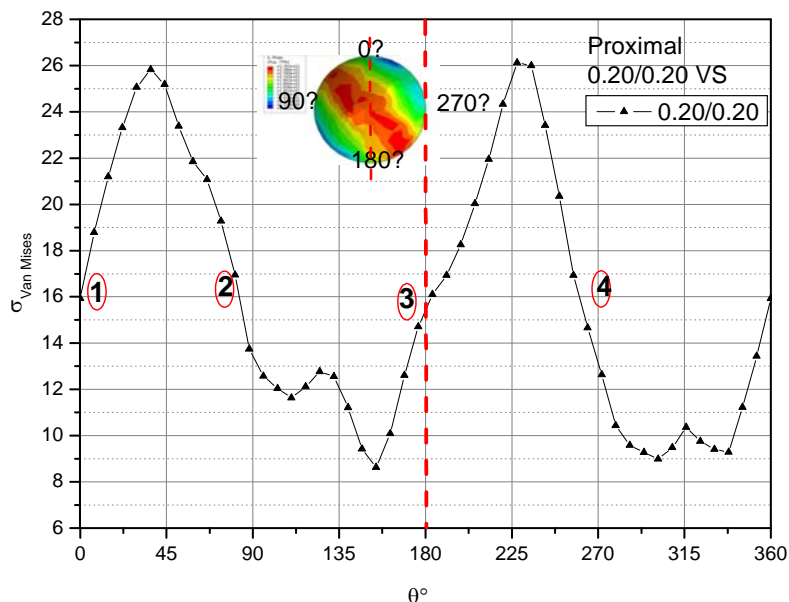

Fig. 6 Variation of the Von Mises stresses in the proximal area of cement around the cavity as a function of its shape

The cavity is located in the portion of the cement more strongly mechanically stressed. That is to say, in the proximal area of the distal cement is very close to the vicinity of the interface to the implant. It is in this part or the risk of damage to the cement is higher. An analysis of the distribution of the equivalent von Mises stress and its induced intensity in the bone cement around the cavity was carried out.

The results thus obtained are shown in Fig. 6. The latter shows that the level of the induced Von Mises stress in the bone cement around the cavity has two maxima corresponding substantially to the angles of 45° and 225° ($\pi/4$ - $5\pi/4$) and two minima at 157° and 300° around the cavity. These constraints don't orthopedic cement voltage whose intensity depends on the position around the cavity.

The results illustrated in this figure show that the presence of a cavity located in the cement in very close vicinity of the interface with the implant and subjected to mechanical stresses induced stresses equivalent intensity which tends towards that of rupture traction cement. Such stresses can lead to loosening of the prosthesis. This level of the equivalent stress may explain the combined effect of interaction of the stress fields cement interface and cement cavity.

3.5 Effect of interaction cavity – cavity

If the volume fraction of cavities in the bone cement facilitates material transport (transport of antibiotics) long distance, it is a factor of the mechanical behaviour of the cement. Indeed, the presence of cavities can weaken the cement interaction effect and thus determines the durability of total hip prosthesis.

The objective of this part of the work is to analyse numerically dimensionally element method of the interaction effect cavity-cavity, characterized by interdistance cavity-cavity (Fig. 7), the

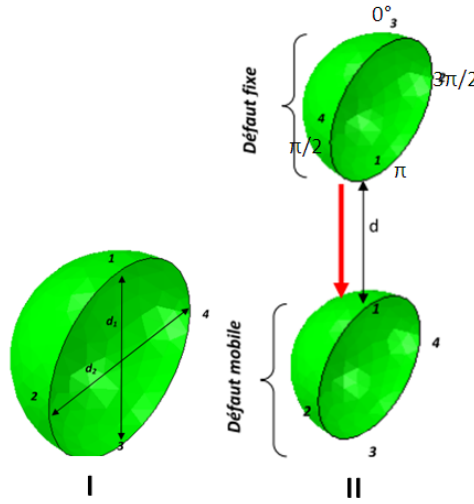

Fig. 7 Schematic representation of the inter-cavity distance simulating their volume fraction of these defects in the cement

level and distribution the equivalent stress of Von induced placed in the bone cement between two cavities.

In Figs. 8 and (b) is shown in the variation of the equivalent stress of Von Mises induced in cement in its proximal and distal portions according to the position defined by the angle θ , the second cavity relative to the first. This figure clearly shows that compared to a single cavity, the location of a second adjacent near another armature in cement between these two cavities a much more significant and equivalent stress regardless of its position. This is essentially due to the interaction of the fields induced stresses in the cement around these two cavities. Note, however, a significant increase in constraints on positions 2, 3 and 4 (Fig. 6) in the glue around the recess in question. This increase is much more pronounced in the distal part of cement (Fig. 8(b)).

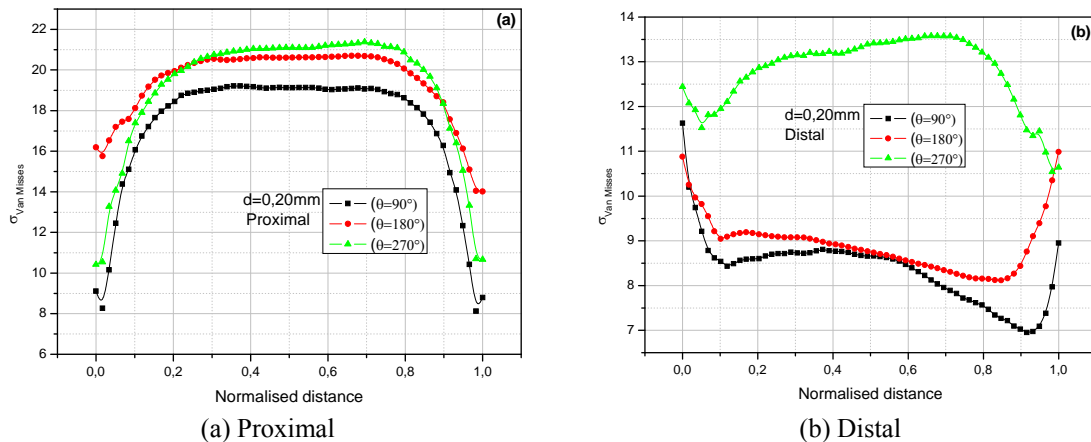

Fig. 8 A variation of the equivalent Mises stresses induced in the Von bone cement according to the position defined by the angle θ , the second cavity relative to the first

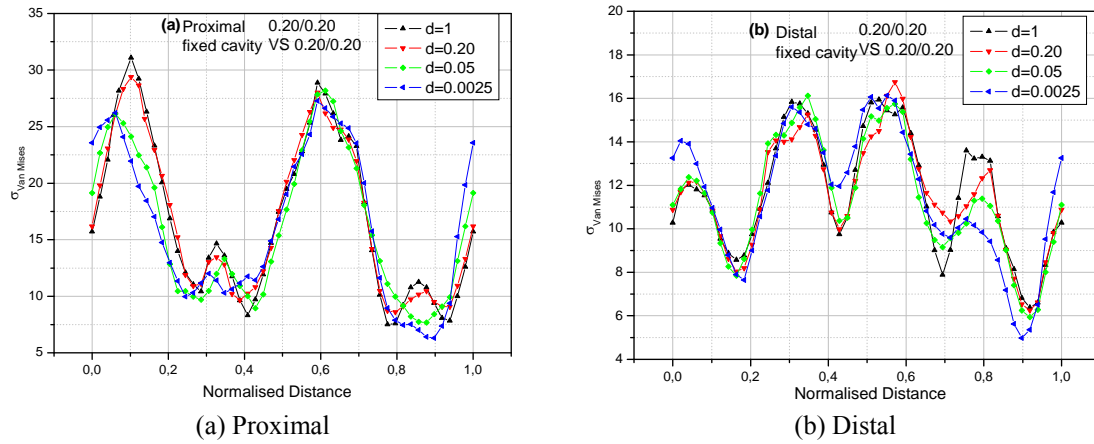

Fig. 9 Variation of the Von Mises stresses around the cavity in function of the fixed distance separating the mobile from the second cavity positioned at $0^\circ-\pi$

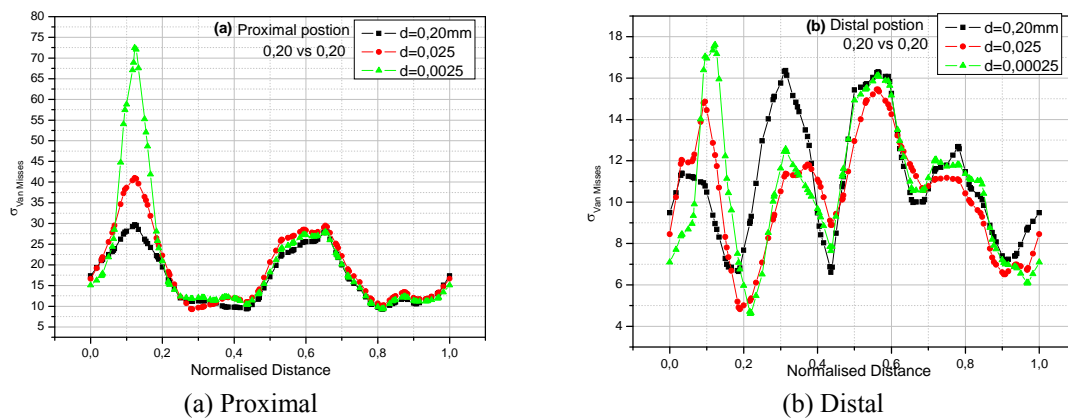

Fig. 10 A variation of the equivalent Von Mises stresses around the fixed cavity depending on the distance separating the movable cavity positioned $\pi/4-5\pi/4$

We analysed the effect of the interdistance (d) -cavity cavity (Fig. 7(II) and (III)) on the level of induced stress in the equivalent cement defects between two aligned at $0^\circ-\pi$ with respect to their centres gravity (Fig. 5). The variation of the stress induced Von bone cement placed in the cavity around the fixed depending on the distance separating it from the second set to 0° mobile cavity $-\pi$ (Fig. 8) As shown in Fig. 9. The latter shows that, compared to a single cavity (Fig. 7) a reconciliation of the fixed to mobile default led to an intensification of the equivalent stress in the cement between the two cavities in its proximal and distal portions. It is in the $\pi-5\pi/4$ area of cement around the fixed cavity that the interaction effect between these two cavities is marked. This effect tends to disappear in other parts of the cement around the defect.

In Fig. 11 illustrates the variation of the von Mises stress around the fixed cavity depending on the distance separating the mobile from the second cavity positioned $\pi/4-5\pi/4$. Fig. 11(a) shows a gradual trend of this fault in the still leads in cement stresses very high intensities. In fact, a location in the cement of two adjacent cavities very close to one another and oriented in this direction causes the cement in between these two defects, in its proximal part, a stress intensity of

about three higher than the breaking stress in tension and comparable to that of its compressive strength intensity. A significant increase in the equivalent stress is observed in the cement between the two cavities adjacent to each other in the distal portion (Fig. 10(b)).

4. Discussions

The porosity in the bone cement plays a key for the dissemination of antibiotic role, It is a way to transfer.

- The obtained results in this work show that its presence in the bone cement is a source of stress concentration by notch effect.

- This effect is even more important that the cavity is located in the very near vicinity of the interface with the implant.

- This cavity-interface interaction weakens the cement strength. The interaction of the stress fields in this highly localized near the interface and cavity results of Von Mises stress in the cement between these two equivalent in the tensile breaking stress of the component defect. Such a position of the cavity has a higher risk of loosening of total hip prosthesis. This behaviour is greatly increased by the localization in this area of the cement, both very close to the cavity from one another. Indeed the level of induced stresses in the glue between these two defects it reaches its breaking stress in compression.

5. Conclusions

The obtained results in this study show that:

- The seat of stress concentration is implanting-cement interface, the equivalent stress of Von Mises induced in cement, in its proximal part, the very close vicinity of the interface tends to stress the tensile strength of this component;

- The presence of cavity in the bone cement is an additional source of stress by notch effect. Its location near the interface leads to higher stresses in the cement. This increase is the result of two effects: interaction cavity cement interface and cement;

- The equivalent stress Von Mises largest induced in the cement at the interface with the cavity is located along an axis oriented from $\pi/4-3\pi/2$ from the center of gravity

- Compared to a cavity, the existence of a second cavity adjacent one in the bone cement generates stresses higher Von Mises. The intensity of these stresses is dependent on the second position relative to the first.

Reference

- Benbarek, S., Bachir Bouiadjra, B., Achour, T., Belhouari, M. and Serier, B. (2007), "Finite element analysis of the behaviour of crack emanating from microvoid in cement of reconstructed acetabulum", *Mater. Sci. Eng.*, **457**(1-2), 385-391.
- Bachir Bouiadjra, B., Belarbi, A., Benbarek, S., Achour, T. and Serier, B. (2007), "FE analysis of the behaviour of microcracks in the cement mantle of reconstructed acetabulum in the total hip prosthesis", *Comput. Mater. Sci.*, **40**(4), 485-491.
- Benbarek, S., Bachir Bouiadjra, B., Mokhtar, M.B., Achour, T. and Serier, B. (2013), "Numerical analysis

- of the crack growth path in the cement mantle of the reconstructed acetabulum”, *Mater. Sci. Eng., C*, **33**(1), 543-549.
- Serier, B., Bachir Bouiadjra, B., Benbarek, S. and Achour, T. (2009), “Analysis of the effect of the forces during gait on the fracture behaviour in cement of reconstructed acetabulum”, *Comput. Mater. Sci.*, **46**(2), 267-274.
- Bouziane, M.M., Bachir Bouiadjra, B., Benbarek, S., Tabeti, M.S.H. and Achour, T. (2009), “Finite element analysis of the behaviour of microvoids in the cement mantle of cemented hip stem: static and dynamic analysis”, *Mater. Des.*, **31**(1), 545-550.
- Krause, W. and Mathis, R.S. (1988), “Fatigue properties of acrylic bone cements: review of the literature”, *J. Biomed. Mater. Res.*, **22**(A1 Suppl), 37-53.
- ABAQUS Ver 6-5 (2004), User Guide.
- Huiskes, R. (1980), “Some fundamental aspects of human joint replacement: analyses of stresses and heat conduction in bone-prosthesis structures”, *Acta Orthopaedica*, **51**(S185), 3-208.
- Nuño, N. and Avanzolini, G. (2002), “Residual stresses at the stem-cement interface of an idealized cemented hip stem”, *J. Biomech.*, **35**(6), 849-852.
- Lewis, G. (1997), “Properties of acrylic bone cement: state of the art review”, *J. Biomed. Mater. Res.*, **38**(2), 155-182.
- Waanders, Daan., Janssen, Dennis., Kenneth, A. and Mann Verdonshot, Nico. (2012), “The behavior of the micro-mechanical cement-bone interface affects the cement failure in total hip replacement”, *J. Biomech.*, **44**(2), 228-234.
- Zouambi, Leila., Serier, Boualem., Fekirini, Hamida. and Bachir Bouiadjra, Belabbes. (2013), “Effect of the cavity-cavity interaction on the stress amplitude in orthopedic cement”, *J. Biomater. Nanobiotechnol.*, **4**(1), 30-36.