

Flexural strength of circular concrete-filled tubes

Minsun Lee¹ and Thomas H.-K. Kang^{*1,2}

¹Department of Architecture and Architectural Engineering, Seoul National University,
1 Gwanak-ro, Gwanak-gu, Seoul 08826, Korea

²Department of Civil and Environmental Engineering, University of Illinois at Urbana-Champaign,
205 North Mathews Ave., Urbana 61810, USA

(Received September 12, 2016, Revised September 21, 2016, Accepted September 22, 2016)

Abstract. The flexural strength of circular concrete-filled tubes (CCFT) can be estimated by several codes such as ACI, AISC, and Eurocode 4. In AISC and Eurocode, two methods are recommended, which are the strain compatibility method (SCM) and the plastic stress distribution method (PSDM). The SCM of AISC is almost the same as the SCM of the ACI method, while the SCM of Eurocode is similar to the ACI method. Only the assumption of the compressive stress of concrete is different. The PSDM of Eurocode approach is also similar to the PSDM of AISC, but they have different definitions of material strength. The PSDM of AISC is relatively easier to use, because AISC provides closed-form equations for calculating the flexural strength. However, due to the complexity of calculation of circular shapes, it is quite difficult to determine the flexural strength of CCFT following other methods. Furthermore, all these methods give different estimations. In this study, an effort is made to review and compare the codes to identify their differences. The study also develops a computing program for the flexural strength of circular concrete filled tubes under pure bending that is in accordance with the codes. Finally, the developed computing algorithm, which is programmed in MATLAB, is used to generate design aid graphs for various steel grades and a variety of strengths of steel and concrete. These design aid graphs for CCFT beams can be used as a preliminary design tool.

Keywords: flexural strength; circular concrete-filled tube; computing algorithm; design aid graph

1. Introduction

Recently, many long span structures are being built (Kang *et al.* 2009, Yang and Kang 2011, Lee *et al.* 2016), and the usage of concrete filled tubes (CFTs) for long span structures is becoming greater because of their structural advantages such as greater stiffness and strength compared to bare steel tubes (Probst *et al.* 2010, Kim *et al.* 2014, Kang *et al.* 2015, Manikandan and Sukuma 2016). This trend promotes the use of CFT beams.

The flexural strength of a CFT can be estimated according to available codes (Eurocode 4 2004, Leon and Hajjar 2008, AISC 2011a, b, Kang *et al.* 2011, ACI 318 2014, Lee *et al.* 2016). Despite many codes being available for composite structures worldwide, design codes are not

*Corresponding author, Associate Professor, E-mail: tkang@snu.ac.kr

consistent in design philosophy or recommendations of material or section. Furthermore, it is more difficult to estimate the flexural strength of circular CFTs than rectangular CFTs, due to the complicated computation associated with a circular section (especially thick-walled). Thus, this study aims to provide numerical analysis guides for calculating the flexural strength of the circular CFT under pure bending. This means that the study only addresses the nominal moment capacity of the CCFT with no axial force. Even though this situation represents one point of the axial load-bending interaction curve (P-M curve) for beam-column members, it is meaningful in itself to obtain the flexural strength of the CCFT with a high degree of accuracy. In addition, it is significant not only to determine the nominal moment capacity of CCFT beams, but also to describe a P-M curve as an important reference point. Therefore, the start of this paper identifies the differences between the ACI, AISC, and Eurocode 4 methods. It then proposes a computer program to calculate the flexural strength of the CCFT that reflects each difference. The current codes do not provide detailed computing algorithm for circular tubes, except for the plastic stress distribution method of AISC. The proposed method gives accurate nominal moment strength values that are in accordance with the current codes. Currently, no other information is available that instructs how to calculate CCFT's moment strength based on the strain compatibility method (SCM) of ACI, AISC, and Eurocode 4 and PSDM of Eurocode 4. Finally, design aid graphs for the flexural capacity of circular concrete filled tubes prepared by using the proposed computing program are presented, which would be useful at the preliminary design phase, and the resultant values according to each method and different material properties are compared.

2. Review on design codes

As mentioned earlier, there are many available design codes for the flexural strength of CCFT. The applied design codes differ from country to country, and the codes are not consistent each other. Consequently, the calculated value of the flexural strength or moment capacity of the CFT beams under pure bending varies depending on the design code. This study addresses ACI, AISC, and Eurocode 4, which provide methods of estimating the flexural strength of a concrete filled tube.

First, the ACI building code and AISC-LRFD specification provide design rules for composite members in the United States. While the ACI building design code (ACI 318-14) provides only one method, AISC provides two methods: the strain compatibility method (SCM) and the plastic stress distribution method (PSDM). However, the ACI method is conceptually the same as the strain compatibility method of AISC-LRFD (2011), which is one of the two methods that AISC provides. The ACI method regards the CFT as regular reinforced concrete by replacing the steel tube with the same amount of reinforcement bars. The moment capacity of the CFT beam is computed based on the assumption of 0.003 of concrete compressive strain. Moreover, according to ACI 318-14 Section 22.2.2.3, the relationship between concrete compressive stress distribution and concrete strain can be assumed in several shapes, such as rectangular or trapezoidal. Even though there are many ways to assume the relationship between concrete compressive stress distribution and strain, this study only deals with the rectangular compressive stress distribution of concrete, because it is the most common assumption. Thus, this study uses the assumption that the compressive strength of concrete is an equivalent rectangular stress distribution, and its value is $0.85f'_c$ as Whitney rectangular stress distribution, where f'_c is the specified concrete compressive strength. The depth of the concrete equivalent stress block, a , is the same as β_1c , but the tensile

strength of concrete is ignored, where β_1 is the Whitney stress block depth factor and c is the neutral axis depth from the extreme compression fiber. For steel, it is assumed to follow a perfectly elasto-plastic stress-strain relationship and have a perfect bonding condition between the steel tube and concrete.

AISC suggests two methods. PSDM is the other method that is suggested by AISC, and it is different from the ACI method or the SCM of AISC. The PSDM is a simplified version of the SCM, and computes the strength of the section based on the plastic stress distribution. Concrete compressive stress in the plastic state for circular concrete filled tubes is assumed to be uniform stress of $0.95f'_c$. As mentioned above, the ACI method assumes that the compressive uniform stress of concrete is $0.85f'_c$, and in fact, AISC also makes the same assumption for rectangular concrete filled tube (RCFT). However, the PSDM of AISC considers the confinement due to hoop stresses in circular tubes, so it uses the factor of 0.95 for the uniform stress of concrete of CCFTs. The depth of the concrete equivalent stress block equals the distance from the extreme compressive fiber of concrete to the neutral axis (different from the Whitney stress block depth). In particular, only the PSDM of AISC provides the equations for computing the flexural strength of the CCFT, and those equations are presented as below (AISC 2011). For a CCFT, the moment capacity M_n (or M_B as used in AISC) can be calculated as

$$M_B = F_y Z_{sB} + \frac{0.95f'_c Z_{cB}}{2} \tag{1}$$

where F_y , Z_{sB} , f'_c , and Z_{cB} denote the yield strength of steel tube, the plastic section modulus of steel tube at point B where no axial force is applied to the CCFT as illustrated in Fig. 1(a), the compressive strength of concrete, and the plastic section modulus of concrete at point B, respectively.

Here, Z_{sB} and Z_{cB} are also provided as follows

$$Z_{sB} = \frac{(d^3 - h^3)}{6} \sin\left(\frac{\theta}{2}\right) \tag{2}$$

$$Z_{cB} = \frac{h^3 \sin^3\left(\frac{\theta}{2}\right)}{6} \tag{3}$$

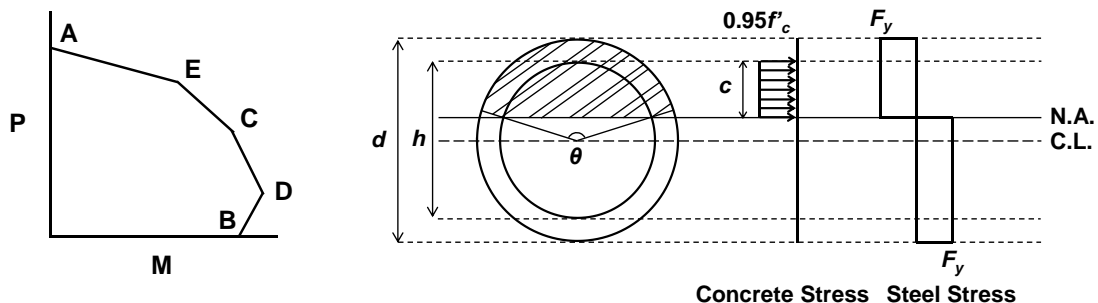

(a) P-M curve (b) Section and stress distributions of CCFT at point B of P-M curve

Fig. 1 Section and stress distributions of CCFT under pure bending with P-M curve

*The figures are adopted from and applied by AISC 2011.

Eqs. (2)-(3) show that there are several parameters: d , h , and θ . Fig. 1(b) shows these three parameters, where d is the outer diameter of the CCFT, h is the diameter of the concrete section or inner diameter of the steel tube, and θ is the angle that defines the location of the plastic neutral axis at the inner face of the steel. This third parameter can be calculated by the following equation

$$\theta = \frac{0.0260K_c - 2K_s}{0.0848K_c} + \frac{\sqrt{(0.0260K_c + 2K_s)^2 + 0.857K_cK_s}}{0.0848K_c} \quad (4)$$

where

$$K_c = f'_c h^2 \quad (5)$$

$$K_s = F_y \left(\frac{d-t}{2} \right) t \quad (6)$$

By using these equations, hand calculation to estimate the flexural strength of a CCFT is finally possible only in the PSDM of AISC. However, the PSDM allows errors during the process of inducing the plastic section modulus of concrete and steel at point B, so the flexural capacity by equations in the PSDM of AISC is not exact, but an approximated value of the CCFT (Geschwindner 2010). The degree of approximation becomes larger for thick-walled CCFTs.

Eurocode 4 makes it possible to compute the capacity of the concrete filled tube in two ways called the general method and the simplified method, which are the strain compatibility method (SCM) and the plastic stress distribution method (PSDM), respectively, like AISC. However, in various aspects, the SCM of Eurocode 4 is different from the ACI method or the SCM of AISC; and the PSDM of Eurocode 4 is also different from the PSDM of AISC.

Like the ACI method or SCM of AISC, according to Eurocode 2 Section 3.1.7, the stress-strain relations for concrete can be assumed in three ways: parabolic, trapezoidal, or rectangular. However, this study uses just the rectangular shape for concrete stress distribution, because it is the most common and convenient assumption. In the SCM of Eurocode 4, the ultimate compressive strain, uniform compressive stress, and depth of the equivalent rectangular stress distribution for concrete are diverse depending on the strength of concrete. For example, if the concrete strength is 27 MPa, the ultimate compressive strain of concrete is 0.0035, the uniform compressive stress is f'_c , and the depth of the equivalent rectangular stress distribution is $0.8c$; but if the concrete strength is 60 MPa, the ultimate compressive strain of concrete is 0.0029, the uniform compressive stress is $0.95f'_c$, and the depth of the equivalent rectangular stress distribution is $0.775c$. For tension, like the ACI method or the SCM of AISC, the tensile strength of concrete is ignored, and steel is assumed to have a perfectly elasto-plastic relationship.

The PSDM of Eurocode 4 also has some aspects that are in common with, and different from, the PSDM of AISC. Like the PSDM of AISC, the PSDM of Eurocode 4 also uses rigid plastic analysis, so the moment capacity is obtained based on the assumption that there is full interaction between the steel and concrete. The compressive stress distribution of concrete is assumed to have an equivalent rectangular stress distribution; but the value is f'_c , which is different from the value for the PSDM of AISC, where its depth is once again the distance from the extreme compressive fiber to the neutral axis.

3. Algorithm of calculating flexural strength of circular concrete filled tube

Even though several methods make possible to calculate the flexural strength of CFT, it is very tough to calculate the flexural strength of CFT according to each method due to its complexity and delicate differences between each method. Moreover, it is much more difficult to calculate that of circular shaped concrete filled tube due to the shape of section. For this reason, there is a need to use a computer program to compute the flexural strength of circular concrete filled tube (CCFT) with getting accuracy and convenience so that a computing program is suggested in this study. The algorithm of the suggested program which is coded by MATLAB is explained step by step as below.

Before computing the flexural strength, the way of separating section should be carefully considered and decided for section analysis. That is because it can be a main cause of errors by making missing or additional parts of section as in the following examples. If the sections of CCFT are cut by circular segment as shown in Fig. 2, not only the additional concrete part but also the missing parts of steel are formed.

However, if the sections of CCFT are divided by circular sector as shown in Fig. 3, the additional concrete part is no longer formed, but both ends of steel parts are not included, so errors still exist.

Therefore the following way to divide the section for sectional analysis is newly proposed in this study. The section is first separated by the composed materials, steel and concrete, and the steel is divided into two parts, inner steel core and total section, which is composed of the inner steel core and outer steel crust. These three detached components of inner steel core, total section, and concrete are independently analysed, and according to the contribution of each component to the CCFT, the CCFT is analysed as shown in Fig. 4. In other words, the sectional analysis of the inner steel core is subtracted from that of the total section, and the sectional analysis of

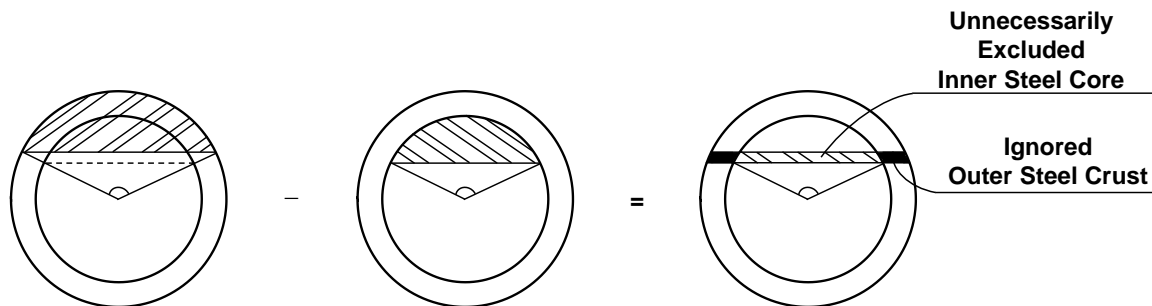

Fig. 2 Errors caused by circular segment analysis for steel tube (modified from Geschwindner. 2010)

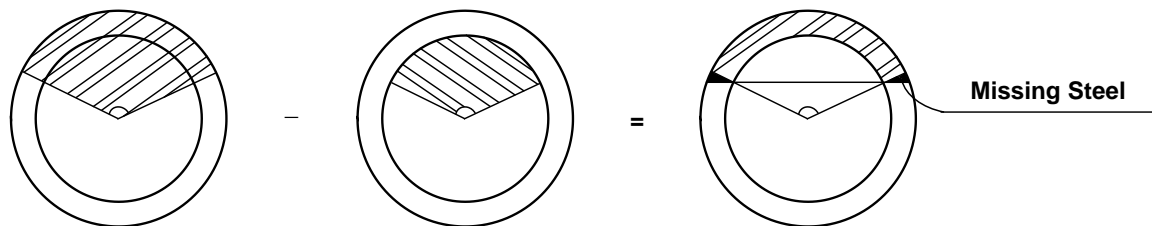

Fig. 3 Errors caused by circular sector analysis for steel tube (modified from Geschwindner. 2010)

concrete is added instead. By this means, there is no possibility of getting additional or missing parts of a section, so errors can be avoided, and this is applied to make the suggested computing program.

Fig. 5 shows the logical flow chart of computing the flexural strength of the CCFT that is applied to the suggested program by using MATLAB. The first step of the program is to input data that are the material properties of the CCFT by user choice. The minimum number of needed material properties to obtain the flexural strength is five, which are the outer steel diameter b_o , thickness of steel t , yield stress of steel F_y , Young's modulus of steel E_s , and strength of concrete

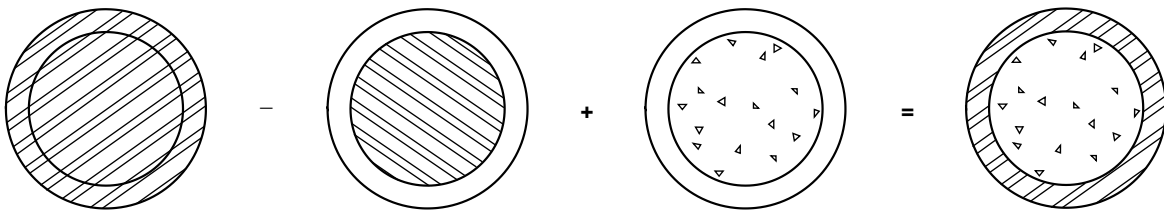

Fig. 4 Conceptual diagram for calculating program

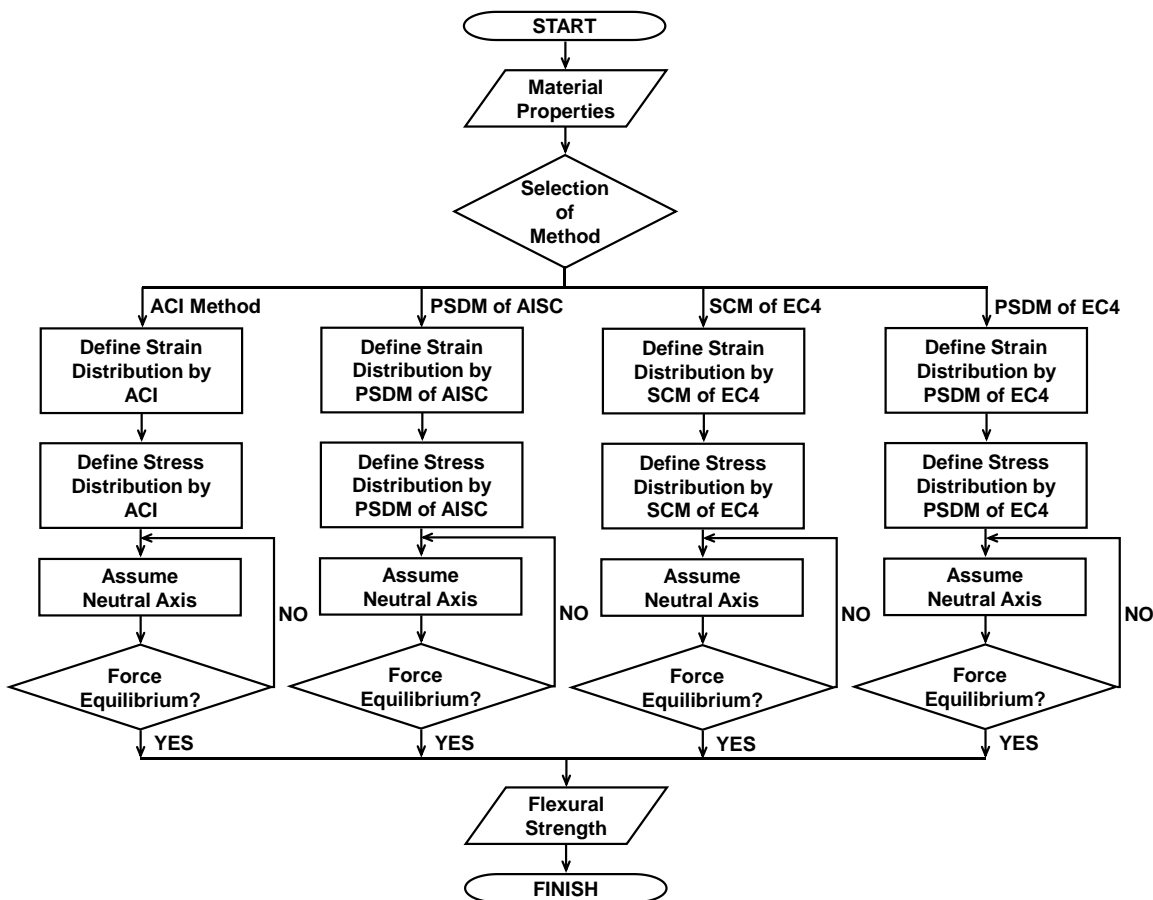

Fig. 5 Flow chart for calculating the flexural strength of CCFT

f'_c . It is possible to compute the flexural strength of any kind of CCFT by using this algorithm, because the first step of the algorithm accepts whatever material properties of CCFT a user enters.

The next step is selecting the method to analyse the CCFT. This study addresses five methods, which are the ACI method, the SCM of AISC, the PSDM of AISC, the SCM of Eurocode 4, and the PSDM of Eurocode 4, so the user can choose among those five methods. After selecting the needed method, one is finally ready to begin sectional analysis for computing the nominal moment capacity of the CCFT.

As mentioned in the previous section, according to the assumptions of each method, the stress distributions of concrete and steel are different, so the program is designed to select the appropriate stress distributions of concrete and steel as in Table 1. These procedures that define the strain and stress distributions are the third and fourth steps of the algorithm, and the same procedures are repeated in each method according to the method.

Table 1 Strain and stress distributions according to each method

Method	Strain and stress distributions
ACI	<p>0.003 F_y/E_s $0.85f'_c$ F_y t d_1 d_2 d_3 d_4 $\beta_1 c$ N.A. C.L. Strain Concrete Stress Steel Stress</p>
PSDM of AISC	<p>0.003 F_y/E_s $0.95f'_c$ F_y t d_1 d_2 d_3 d_4 c N.A. C.L. Strain Concrete Stress Steel Stress</p>
SCM of Eurocode 4	<p>ϵ_{cu} F_y/E_s $\eta f'_c$ F_y t d_1 d_2 d_3 d_4 λc N.A. C.L. Strain Concrete Stress Steel Stress</p>

Table 1 Continued

Method	Strain and stress distributions
PSDM of Eurocode 4	

For example, Fig. 6 describes the strain distribution and the stress distribution according to the ACI method in more detail. First, the steel and concrete have the same strains, and the strain distribution is linear. From this strain distribution, the stress distributions of concrete and steel can also be determined. In the ACI method, while the stress distribution of concrete is assumed to be an equivalent rectangular block, the stress distribution of steel is different from that of concrete. Moreover, the strain or stress distribution of steel can be divided into four zones, according to the meaning of each location. The suggested program in this study uses these four zones in the computing process. The first zone is from the extreme compression fiber to the point where the steel starts to yield in the compression region, and the second zone is from the end of the first zone to the neutral axis. The third zone is from the neutral axis to the point where the steel starts to yield in the tension region, and the last zone is from the end of the third zone to the extreme tension fiber. The definitions of those four zones are available not only in the ACI method, but also in the other methods.

Through the definitions of four zones and stress distributions corresponding to each method, the suggested program finds the neutral axis. The neutral axis is located where the sum of forces from all materials and zones becomes zero, so by using this fact, the neutral axis can be

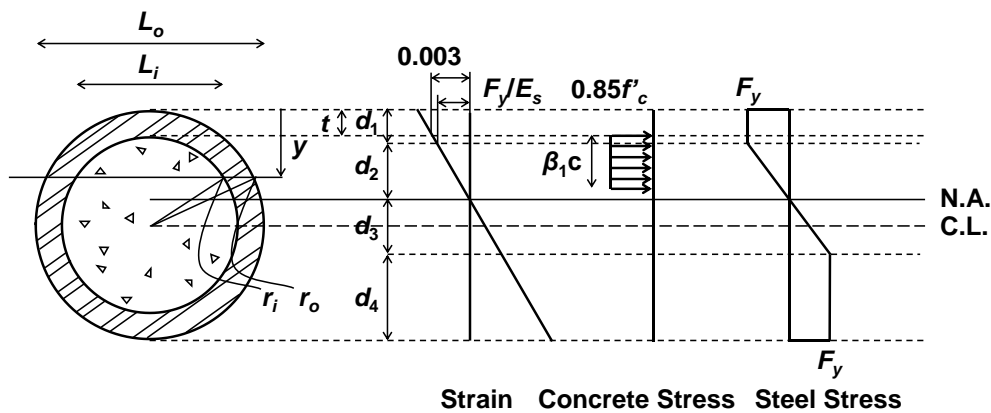

Fig. 6 Strain and stress distributions of concrete and steel in the ACI method

mathematically found. To get all the forces from all materials and zones, the areas and stresses at the corresponding locations clearly need to be determined.

In addition, to determine the corresponding area, it is necessary to know the values of variables, d_1 , d_2 , d_3 , and d_4 , which are the distances in zones 1, 2, 3, and 4, respectively. At the beginning of finding the neutral axis, d_1 is tentatively determined, and d_2 is calculated by using the strain distribution. From the strain distribution, Eq. (9) below is proportionally extracted

$$d_2 = \frac{\varepsilon_s d_1 - \varepsilon_s t}{\varepsilon_{cu} - \varepsilon_s} \quad (9)$$

where ε_s is the steel strain when the steel starts to yield ($\varepsilon_s = F_y/E_s$), and ε_{cu} is the ultimate compressive strain of concrete (=0.003 in all methods, except the SCM of Eurocode 4 where ε_{cu} varies according to the compressive strength of concrete). In all methods, the value of d_3 equals that of d_2 because the compressive and tensile behavior of steel is the same. The value of d_4 is the distance remaining after subtracting d_1 , d_2 , and d_3 from the total distance (the diameter of the outer steel).

The exact stresses at each location need to be determined to compute the exact forces at corresponding locations, as mentioned earlier. In the ACI method and the SCM of Eurocode 4, zones 1 and 4 are already known as they are yielded parts, so the stresses are F_y ; however, the stresses in zones 2 and 3 are yet to be determined. From the stress distribution, formulae for the stresses of zones 2 and 3 can be subtracted as in the following Eqs. (10) and (11). Here, a positive sign means compression and a negative sign means tension

$$f_2(y) = F_y - \frac{y - d_1}{d_2} \times F_y \quad (10)$$

$$f_3(y) = -F_y + \frac{y - d_1}{d_3} \times F_y \quad (11)$$

For the PSDM of AISC and Eurocode 4, it is far easier to get the stress of steel than in the ACI method and the SCM of Eurocode 4. That is because steel is assumed to have a plastic stress distribution in both of the first two methods, so only the magnitude of the yield stress of steel and the sign convention need to be considered.

By using the above stress and distance equations, the forces at each material and each zone can be computed. From this process, the concept as in Fig. 4 is applied to the algorithm, so the forces are investigated by three imaginary components of total section, inner steel core, and inner concrete (Table 2).

Table 2 shows that the integral formulae with L_o and L_i , which are the chord length of the total section and that of the inner steel core as shown in Fig. 6, respectively, represent the area (A) of corresponding locations; and other terms, such as F_y , $f_2(y)$, and $f_3(y)$ in the steel part and kf'_c in the concrete part, represent the stresses at corresponding locations.

By using the equations of Table 2, it is possible to estimate the forces from four zones of steel and concrete. As mentioned above, the program is made to independently analyse the total steel section, inner steel core, and concrete; and it then properly subtracts or adds the results of each material's sectional analysis. Thus the sum of forces is estimated as in Eq. (12), like the basic concept shown in Fig. 4

$$\begin{aligned}\sum F &= F_{outer\ steel} - F'_{inner\ steel} + F_{concrete} \\ &= (F_1 - F'_1) + (F_2 - F'_2) - (F_3 - F'_3) - (F_4 - F'_4) + F_{concrete}\end{aligned}\quad (12)$$

The program keeps iteratively operating the same process until the sum of the forces is zero; but after the sum of forces reaches zero, the neutral axis can be found, and the next step, which is calculating the flexural strength of CCFT under the pure bending case, can proceed. In the same manner as calculating the sum of forces, the flexural strength of CCFT is computed as in Eq. (13), like the basic concept.

Table 2 Forces of steel and concrete at each zone

	SCM of ACI and Eurocode 4	PSDM of AISC and Eurocode 4
Total section (Inner steel core + Outer steel crust)	$F_1 = F_y \int_0^{d_1} L_o dy$ $F_2 = \int_{d_1}^{d_1+d_2} L_o f_2(y) dy$ $F_3 = \int_{d_1+d_2}^{d_1+d_2+d_3} L_o f_3(y) dy$ $F_4 = F_y \int_{d_1+d_2+d_3}^{2r_o} L_o dy$ <p>where $L_o = 2\sqrt{r_o^2 - (r_o - y)^2}$</p>	$F_1 = F_y \int_0^{d_1} L_o dy$ $F_2 = F_y \int_{d_1}^{d_1+d_2} L_o dy$ $F_3 = F_y \int_{d_1+d_2}^{d_1+d_2+d_3} L_o dy$ $F_4 = F_y \int_{d_1+d_2+d_3}^{2r_o} L_o dy$ <p>where $L_o = 2\sqrt{r_o^2 - (r_o - y)^2}$</p>
Inner steel core	$F'_1 = F_y \int_0^{d_1} L_i dy$ $F'_2 = \int_{d_1}^{d_1+d_2} L_i f_2(y) dy$ $F'_3 = \int_{d_1+d_2}^{d_1+d_2+d_3} L_i f_3(y) dy$ $F'_4 = F_y \int_{d_1+d_2+d_3}^{2r_o} L_i dy$ <p>where $L_i = 2\sqrt{r_i^2 - (r_o - y)^2}$</p>	$F'_1 = F_y \int_0^{d_1} L_i dy$ $F'_2 = F_y \int_{d_1}^{d_1+d_2} L_i dy$ $F'_3 = F_y \int_{d_1+d_2}^{d_1+d_2+d_3} L_i dy$ $F'_4 = F_y \int_{d_1+d_2+d_3}^{2r_o} L_i dy$ <p>where $L_i = 2\sqrt{r_i^2 - (r_o - y)^2}$</p>
Concrete	$F_{concrete} = kf'_c \int_t^{a+t} L_i dy$ <p>where $a = \beta_1 (d_1 + d_2 - t)$ (ACI) or $\lambda (d_1 + d_2 - t)$ (SCM of EC) $k = 0.85$ (ACI) or η (SCM of EC)</p>	$F_{concrete} = kf'_c \int_t^{a+t} L_i dy$ <p>where $a = d_1 + d_2 - t$ $k = 0.95$ (PSDM of AISC) or 1.0 (PSDM of EC)</p>

* β_1 : the factor relating to depth of equivalent rectangular compressive stress block to neutral axis depth (ACI 318-14, Section 22.2.2.4); λ : the factor defining the effective height of the compression zone (Eurocode 2 Eqs. (3.19)-(3.20)); k : the factor defining the effective magnitude of equivalent rectangular compressive stress block; and η : the factor defining the effective strength (Eurocode 2, Eqs. (3.21)-(3.22))

$$\begin{aligned} \sum M &= M_{outer\ steel} - M'_{inner\ steel} + M_{concrete} \\ &= (M_1 - M'_1) + (M_2 - M'_2) - (M_3 - M'_3) - (M_4 - M'_4) + M_{concrete} \end{aligned} \quad (13)$$

Before computing the flexural strength of the CCFT, the moments of all components should be known, and those are presented in Table 3. Compared to the equations in Table 2, the equations in Table 3 just add the term (d_1+d_2-y) . The new term means the moment arm length, so the moment of each component can be induced. By using Eq. (13) and Table 3, the flexural strength of CCFT can be computed. The final step of the suggested program is to print out this flexural strength of the CCFT under pure bending.

Table 3 Moments of steel and concrete at each zone

	SCM of ACI and Eurocode 4	PSDM of AISC and Eurocode 4
Total section (Inner steel core + Outer steel crust)	$M_1 = F_y \int_0^{d_1} L_o (d_1 + d_2 - y) dy$	$M_1 = F_y \int_0^{d_1} L_o (d_1 + d_2 - y) dy$
	$M_2 = \int_{d_1}^{d_1+d_2} L_o f_2(y) (d_1 + d_2 - y) dy$	$M_2 = F_y \int_{d_1}^{d_1+d_2} L_o (d_1 + d_2 - y) dy$
	$M_3 = \int_{d_1+d_2}^{d_1+d_2+d_3} L_o f_3(y) (d_1 + d_2 - y) dy$	$M_3 = F_y \int_{d_1+d_2}^{d_1+d_2+d_3} L_o (d_1 + d_2 - y) dy$
	$M_4 = F_y \int_{d_1+d_2+d_3}^{2r_o} L_o (d_1 + d_2 - y) dy$	$M_4 = F_y \int_{d_1+d_2+d_3}^{2r_o} L_o (d_1 + d_2 - y) dy$
	where $L_o = 2\sqrt{r_o^2 - (r_o - y)^2}$	where $L_o = 2\sqrt{r_o^2 - (r_o - y)^2}$
Inner steel core	$M'_1 = F_y \int_0^{d_1} L_i (d_1 + d_2 - y) dy$	$M'_1 = F_y \int_0^{d_1} L_i (d_1 + d_2 - y) dy$
	$M'_2 = \int_{d_1}^{d_1+d_2} L_i f_2(y) (d_1 + d_2 - y) dy$	$M'_2 = F_y \int_{d_1}^{d_1+d_2} L_i (d_1 + d_2 - y) dy$
	$M'_3 = \int_{d_1+d_2}^{d_1+d_2+d_3} L_i f_3(y) (d_1 + d_2 - y) dy$	$M'_3 = F_y \int_{d_1+d_2}^{d_1+d_2+d_3} L_i (d_1 + d_2 - y) dy$
	$M'_4 = F_y \int_{d_1+d_2+d_3}^{2r_o} L_i (d_1 + d_2 - y) dy$	$M'_4 = F_y \int_{d_1+d_2+d_3}^{2r_o} L_i (d_1 + d_2 - y) dy$
	where $L_i = 2\sqrt{r_i^2 - (r_o - y)^2}$	where $L_i = 2\sqrt{r_i^2 - (r_o - y)^2}$
Concrete	$M_{concrete} = kf'_c \int_t^{a+t} L_i (d_1 + d_2 - y) dy$ where $a = \beta_1 (d_1 + d_2 - t)$ (ACI) or $\lambda (d_1 + d_2 - t)$ (SCM of EC) $k = 0.85$ (ACI) or η (SCM of EC)	$M_{concrete} = kf'_c \int_t^{a+t} L_i (d_1 + d_2 - y) dy$ where $a = d_1 + d_2 - t$ $k = 0.95$ (PSDM of AISC) or 1.0 (PSDM of EC)

* β_1 : the factor relating to depth of equivalent rectangular compressive stress block to neutral axis depth (ACI 318-14, Section 22.2.2.4); λ : the factor defining the effective height of the compression zone (Eurocode 2 Section 3.1.7); k : the factor defining the effective magnitude of equivalent rectangular compressive stress block; and η : the factor defining the effective strength (Eurocode 2, Section 3.1.7)

4. Design aid graphs for circular concrete filled tube

Through the suggested program with the algorithm, the nominal moment capacity for any sort of CCFT can be calculated in any kind of method among the five methods addressed in this study. The following Figs. 7-10 represent the flexural strength of CCFTs based on the ACI method (same with the SCM of AISC), the PSDM of AISC, the SCM of Eurocode 4, and the PSDM of Eurocode 4, respectively.

For each method, there are six flexural strength versus CCFT diameter relationship graphs. Three graphs of these six graphs are divided by the concrete strength, which for one is 27 MPa, and for the other is 60 MPa. In addition, for the same method and same concrete strength, three graphs are generated for the nominal moment capacities of thick, medium, and thin walled CCFT. This study defines the thick, medium and thin walled CCFTs according to their diameter to thickness ratio (b_o/t). The CCFTs with b_o/t values of 20, 35 and 50 are selected to represent thick walled, medium walled, and thin walled CCFTs, respectively.

Furthermore, each graph has four lines, and these represent flexural strengths for the

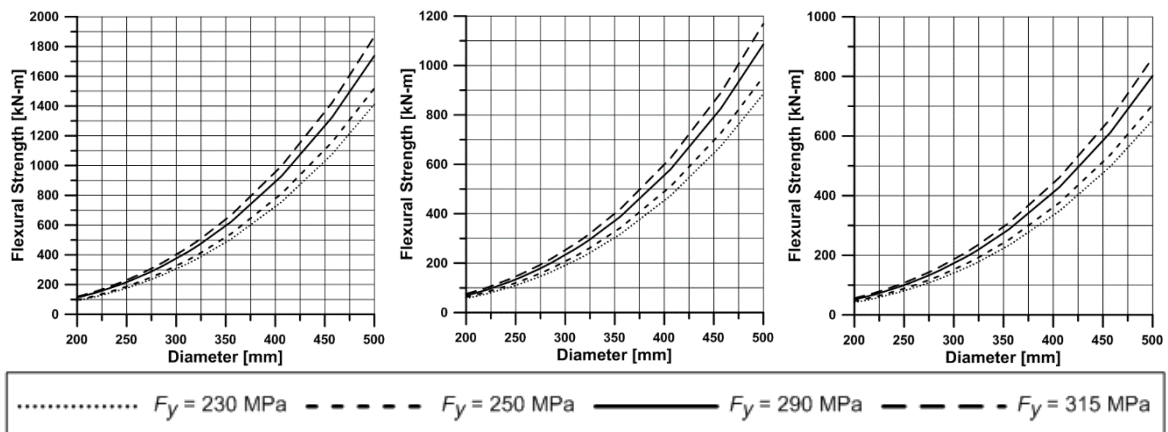

(a) Flexural strength – diameter graph with $f'_c = 27$ MPa

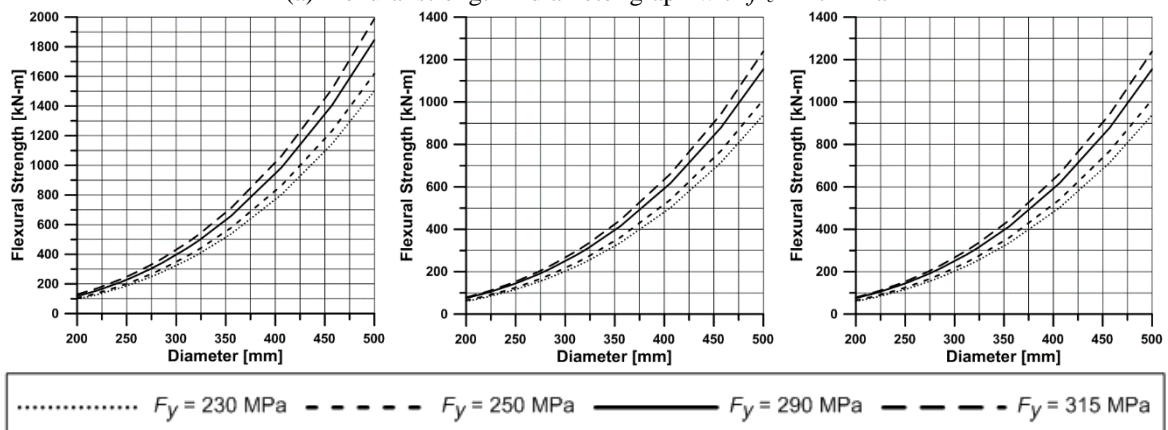

(b) Flexural strength - diameter graph with $f'_c=60$ MPa

Fig. 7 Flexural strength - diameter graph based on the ACI method

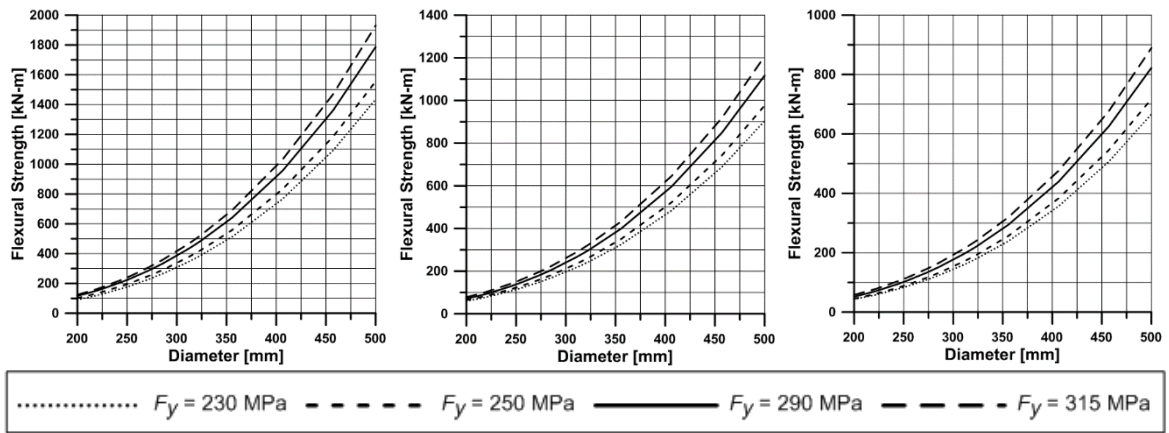

(a) Flexural strength - diameter graph with $f'_c = 27$ MPa

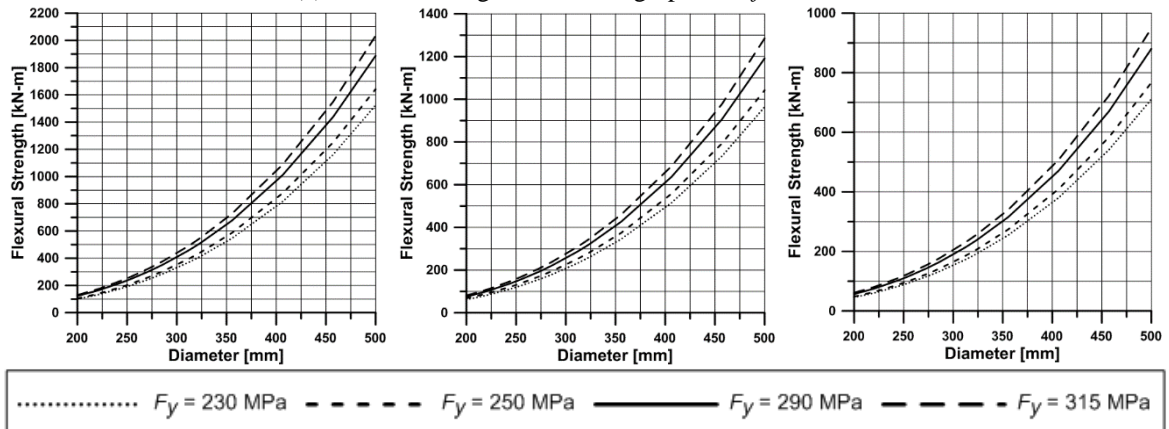

(b) Flexural strength - diameter graph with $f'_c = 60$ MPa

Fig. 8 Flexural strength - diameter graph based on the plastic stress distribution method of AISC

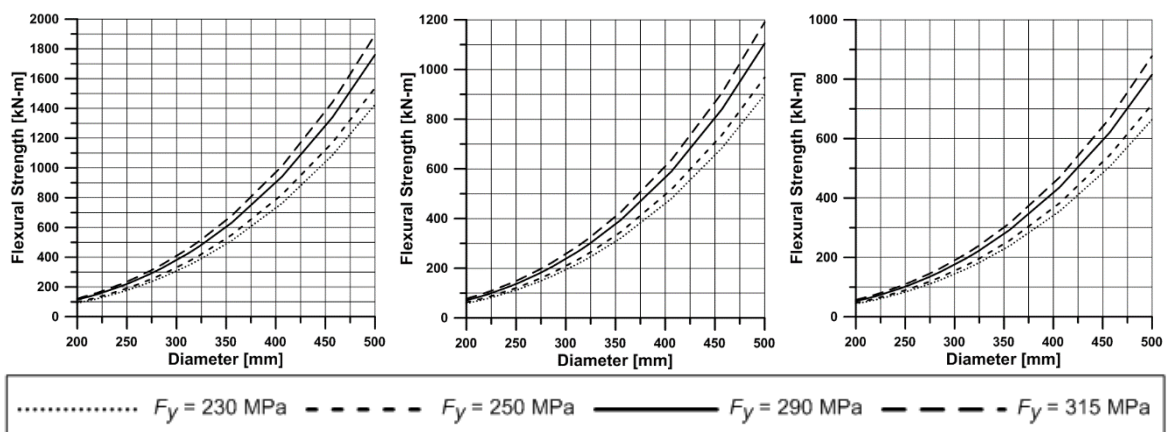

(a) Flexural strength - diameter graph with $f'_c = 27$ MPa

Fig. 9 Flexural strength - diameter graph based on the strain compatibility of Eurocode 4

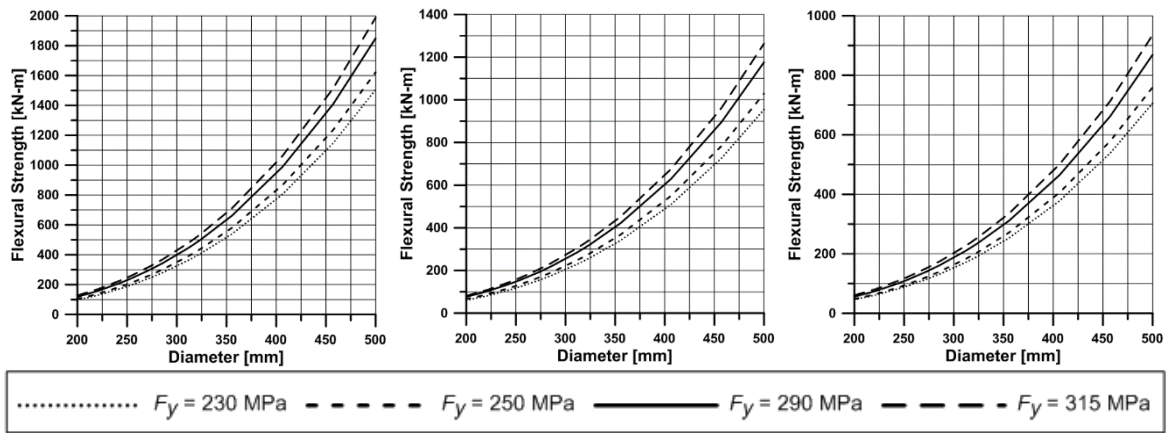

(b) Flexural strength - diameter graph with $f'_c = 60$ MPa

Fig. 9 Continued

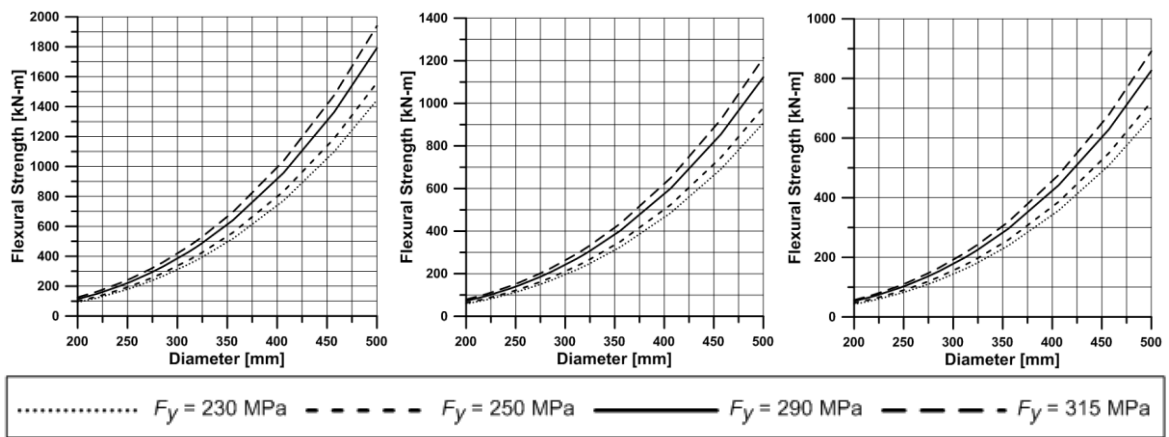

(a) Flexural strength - diameter graph with $f'_c = 27$ MPa

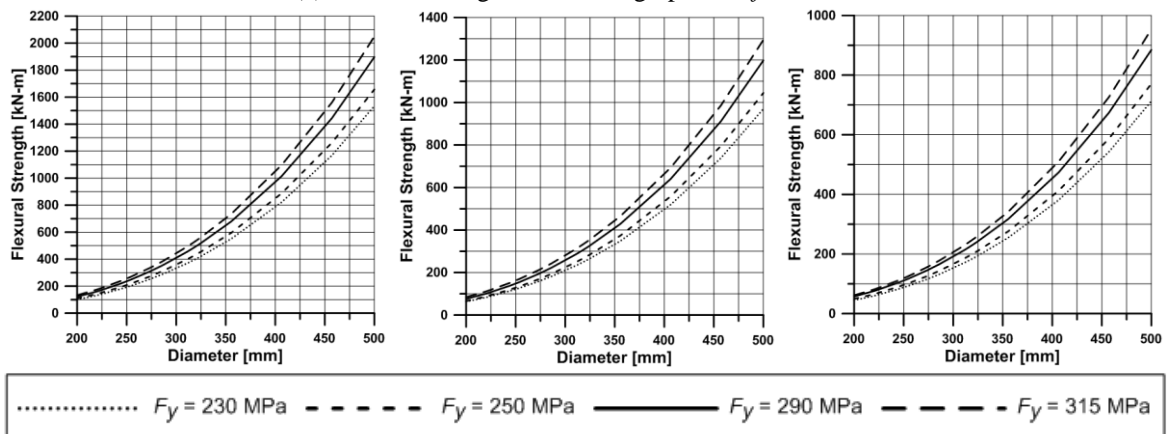

(b) Flexural strength - diameter graph with $f'_c = 60$ MPa

Fig. 10 Flexural strength - diameter graph based on the plastic stress distribution method of Eurocode 4

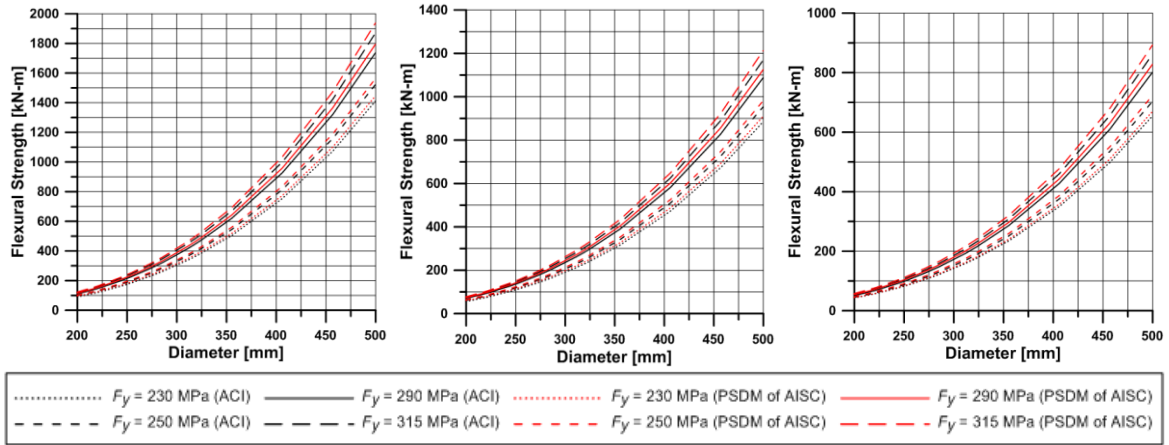

(a) Flexural strength - diameter graph with $f'_c=27$ MPa

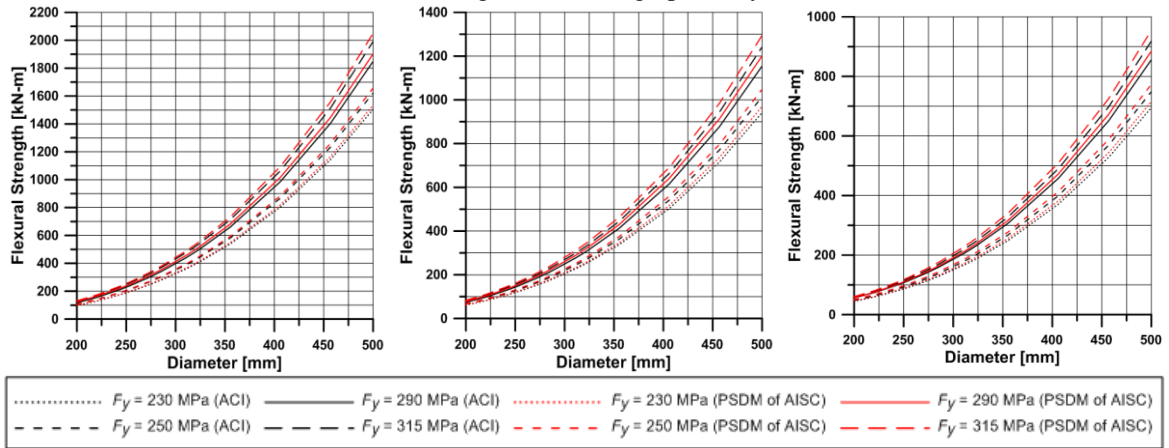

(b) Flexural strength - diameter graph with $f'_c=60$ MPa

Fig. 11 Comparison between the flexural strength - diameter graphs in the ACI method and plastic stress distribution method of AISC

corresponding yield strengths of steel, which are 230, 250, 290, and 315 MPa according to steel grades. The range of CCFT diameters is determined based on the size of steel tubes that are generally used and provided in the construction field.

Figs. 7-10 show that if the strength of concrete is greater, the flexural strength of the CCFT is also greater than the flexural strength of the CCFT with a smaller strength of concrete. Moreover, if the thickness of steel tube is greater, the strength of CCFT is greater than that of CCFT with thinner steel tube. In other words, thick walled CCFT has higher nominal moment capacity compared with medium and thin walled CCFT with the same other conditions. If the yield strength of the steel increases, the nominal moment capacity of the CCFT also increases. Likewise, if the diameter of the CCFT increases, the moment resistance value increases, but it increases exponentially.

When all the methods and codes are compared, the ACI strain compatibility method provides the smallest flexural strength values of CCFTs (Fig. 11), while the PSDM of Eurocode 4 provides

the largest values for all CCFT cases (Fig. 10 vs. 8). Most of all, these generated twenty four design aid graphs can be used for the design of circular concrete filled tube beams at the preliminary design phase. The design aid graphs are especially useful given that hand calculation to estimate the flexural strength of a CCFT is very tough and even that there is no commercial software that allows such calculations.

5. Conclusions

This study investigates the nominal flexural strength of CCFTs calculated according to ACI, AISC, and Eurocode 4. The differences between the methods come from each method's basic concept and/or assumption. These differences are based on different stress distributions of concrete and steel at the ultimate stage. By accurately accounting for these differences, the suggested computing algorithm is programmed to accurately calculate the flexural strength of the CCFT, which is impossible without a computer (except for PSDM of AISC). This developed program is made to solve the problems that are errors caused during circular section calculation by avoiding missing and adding extraneous parts. The program is also configured to account for the material properties of diverse CCFTs. The developed program is used to generate design aid graphs for various steel sections/grades and various strengths of concrete. These design aid graphs for CCFT beams can be used as a preliminary design tool.

It is worth mentioning as a final remark that the confined concrete is not used for nominal strengths in ACI and AISC, and that the accurate sectional analysis with consideration of confined concrete, strain hardening, debonding, etc. is not the purpose of this paper. This paper also does not attempt to give any information regarding the advantages and disadvantages of each code, as it is beyond the scope of the study.

References

- ACI 318 (2014), Building code requirements for structural concrete and commentary, American Concrete Institute, Farmington Hills, MI, USA.
- AISC (2011), Steel construction manual, American Institute of Steel Construction, Chicago, IL, USA.
- AISC (2011), Design examples V14.2, American Institute of Steel Construction, Chicago, IL, USA.
- Eurocode 2 (2004), Design of concrete structures, Part 1.1: General rules and rules for building, European Committee for Standardization, Brussels, Belgium.
- Eurocode 4 (2004), Design of composite steel and concrete structures, Part 1.1: General rules and rules for building, European Committee for Standardization, Brussels, Belgium.
- Geschwindner, L.F. (2010), "Discussion of reinforced concrete members under flexure and combined flexure and direct compression", *Eng. J.*, **47**(2), 483-498.
- Leon, R.T. and Hajjar, J.F. (2008), "Limit state response of composite columns and beam-columns part II: Application of design provisions for the 2005 AISC specification", *Eng. J.*, **45**(1), 21-46.
- Lee, C.-H., Kang, T.H.-K., Kim, S.-Y. and Kang, K. (2016), "Strain compatibility method for the design of short rectangular concrete-filled tube columns under eccentric axial loads", *Constr. Bldg. Mat.*, **121**, 143-153.
- Lee, J.D., Yoon, J.K. and Kang, T.H.-K. (2016), "Combined half precast concrete slab and post-tensioned slab topping system for basement parking structures", *J. Struct. Integr. Maint.*, **1**(1), 1-9.
- Kang T.H.-K., Wallace, J.W. and Elwood, K.J. (2008), "Nonlinear modeling of flat-plate systems", *J. Struct. Eng.*, **135**(2), 147-158.

- Kim, J.-W., Lee, C.-H. and Kang, T.H.-K. (2014), "Shearhead reinforcement for concrete slab to concrete-filled tube column connection", *ACI Struct. J.*, **111**(3), 629-638.
- Probst, A.D., Kang, T.H.-K., Ramseyer, C. and Kim, U. (2010), "Composite flexural behavior of full-scale concrete-filled tubes without axial loads", *J. Struct. Eng.*, **136**(11), 1401-1412.
- Yang, K.-H. and Kang, T.H.-K. (2011), "Equivalent strain distribution factor for unbonded tendon stress at ultimate", *ACI Struct. J.*, **108**(2), 217-226.
- Kang, L., Leon, R.T. and Lu, X. (2015), "Shear strength analyses of internal diaphragm connections to CFT columns", *Steel Compos. Struct.*, **18**(5), 1083-1101.
- Manikandan, P. and Sukuma, S. (2016), "Effect of stiffened element and edge stiffener in strength and behaviour of cold formed steel built-up beams", *Adv. Comput. Des.*, **1**(2), 207-220.