

## An optimization framework to tackle challenging cargo accommodation tasks in space engineering

Giorgio Fasano<sup>\*</sup>, Cristina Gastaldi<sup>a</sup>, Annamaria Piras<sup>b</sup> and Dario Saia<sup>c</sup>

*Thales Alenia Space Strada Antica di Collegno 253, 10146 Torino (TO), Italy*

*(Received September 16, 2013, Revised November 18, 2013, Accepted November 29, 2013)*

**Abstract.** Quite a demanding task frequently arises in space engineering, when dealing with the cargo accommodation of modules and vehicles. The objective of this effort usually aims at maximizing the loaded cargo, or, at least, at meeting the logistic requirements posed by the space agencies. Complex accommodation rules are supposed to be taken into account, in compliance with strict balancing conditions and very tight operational restrictions. The context of the International Space Station (ISS) has paved the way for a relevant research and development activity, providing the company with a remarkable expertise in the field. CAST (Cargo Accommodation Support Tool) is a dedicated in-house software package (funded by the European Space Agency, ESA, and achieved by Thales Alenia Space), to carry out the whole loading of the Automated Transfer Vehicle (ATV). An ad hoc version, tailored to the Columbus (ISS attached laboratory) on-board stowage issue, has been further implemented and is to be used from now on. This article surveys the overall approach followed, highlighting the advantages of the methodology put forward, both in terms of solution quality and time saving, through an overview of the outcomes obtained to date. Insights on possible extensions to further space applications, especially in the perspective of the paramount challenges of the near future, are, in addition, presented.

**Keywords:** analytical cargo accommodation; space module/vehicle loading optimization; static/dynamic balancing; operational constraints; non-standard packing problems with additional conditions; loading optimization; International Space Station (ISS) logistic support; (Columbus) on-board stowage; Automated Transfer Vehicle (ATV, ESA) cargo accommodation

### 1. Introduction

The task of loading items within a space module or vehicle draws back to the so called analytical cargo accommodation. It is well known, in the specialist engineering and logistic context, for being quite demanding, both at the design and at the utilization stages of the spacecraft. The necessity of exploiting the available volume, as much as possible, usually presents the cargo engineer with a first non-trivial commitment. Different optimization criteria, such as the loaded mass maximization, are posed, in compliance with the mission that is to be carried out.

---

<sup>\*</sup> Corresponding author, E-mail: [giorgio.fasano@thalesaleniaspace.com](mailto:giorgio.fasano@thalesaleniaspace.com)

<sup>a</sup> E-mail: [cristina.gastaldi@thalesaleniaspace.com](mailto:cristina.gastaldi@thalesaleniaspace.com)

<sup>b</sup> E-mail: [annamaria.piras@thalesaleniaspace.com](mailto:annamaria.piras@thalesaleniaspace.com)

<sup>c</sup> E-mail: [dario.saia@thalesaleniaspace.com](mailto:dario.saia@thalesaleniaspace.com)

Contractual requirements often deal with operational and human-factor aspects, giving rise, as a consequence, to rather tricky accommodation rules.

Tight conditions usually have to be taken account of, in order to satisfy the attitude control specifications, relevant to the various mission stages (e.g. launch, flight, on-orbit stay and re-entry). The static balancing ones delimit the center of mass location at different levels (e.g. overall spacecraft, single bag/container or rack, if any). Dynamic balancing entails, instead, restrictions on the overall inertia matrix characteristics (generally at system level), relative to a proper reference frame (on the whole contemplating possible spacecraft symmetries).

Cargo items can, in several occurrences, be realistically approximated by single parallelepipeds, but as easily gathered, this is not always the case, especially when significant dimensions and quite intricate shapes are involved. In addition, the available bags and racks may be characterized by curved surfaces (often aimed at exploiting the spacecraft geometry, as, for instance, when it consists of a cylindrical structure). Items can be assigned prefixed positions or orientations, separation planes are often envisaged to partition the containers into sub-volumes, in order to make the internal load easier to handle and, moreover, forbidden zones (due to clearance and accessibility necessities) sometimes have to be foreseen.

Besides the remarkable complexity related, per se, to the technical aspects briefly outlined above, it is worth considering that, usually, quite strict deadlines are imposed to accomplish the task. Last minute upgrades or even significant changes, are, moreover, often expected to arise.

The International Space Station (ISS, c.f. <http://www.nasa.gov>), among a significant number of hard engineering issues, has led to a series of logistic issues to cope with. A foremost subject in this framework concerns the station on-orbit maintenance and re-supply for which a fleet of vehicles is made available by the most prominent space agencies (see <http://www.esa.int>, <http://www.jaxa.jp>, <http://www.nasa.gov>, <http://www.roscosmos.ru>). An overall traffic plan schedules the recurrent up-load and down-load interventions (including the crew transfers). The relevant Cargo Manifest (delivered by NASA) establishes, in particular, for each carrier launch and re-entry, the shipment that is supposed to be transported, from Earth to orbit and vice versa.

ESA has been contributing to the ISS logistics, since 2008, on approximately an annual basis, by accomplishing the previous Automated Transfer Vehicle (ATV, see [http://www.esa.int/Our\\_Activities/Human\\_Spaceflight/ATV](http://www.esa.int/Our_Activities/Human_Spaceflight/ATV)) missions and is carrying on its support by providing the last expected one (ATV5), planned for the end of 2014. In this context, the analytical cargo accommodation task consists of attaining the Cargo Manifest, in compliance with the general ATV accommodation rules, both for the fluid and solid load, in addition to specific requirements. This issue is discussed in Section 2, showing the problematic intrinsic complexity. The approach adopted is outlined there, giving insights on the typology of the results that have been obtained to date.

A further quite interesting application, still involving ISS logistics aspects, concerns the on-board stowage of the overall space system, determining, at least indirectly, strong implications on habitability, safety and crew productivity. This holds, as a specific case, for the European Columbus attached laboratory (see [http://www.esa.int/Our\\_Activities/Human\\_Spaceflight/Columbus](http://www.esa.int/Our_Activities/Human_Spaceflight/Columbus)), currently also utilized to store supply material. In preparation for each prospective up-load step, the relevant on-board stowage objective has to be attained, posing a similar cargo accommodation issue, albeit characterized by proper specificities. This is the topic of Section 3, where the basic problem is described, pointing out the advantages of the overall resolving approach referred to in the present article.

From the methodological point of view, the so called analytical cargo accommodation in space

engineering is a particular application of the more general question of placing items inside containers. This, both in the Operations Research (OR, e.g. Hillier and Lieberman 2001) and Computational Geometry (e.g. Preparata and Shamos 1988) frameworks, is considered a very challenging subject, notoriously belonging to the class of the NP-hard problems (e.g. Williams 1993, <http://glossary.computing.society.informs.org>). The topical literature, where this subject is usually designated as ‘packing’, is certainly vast (comprehensive overviews are provided, for instance, by Cagan *et al.* 2002, Dyckhoff *et al.* 1997 and Ibaraki *et al.* 2008). In this context, whilst, up to now, most of the effort has been devoted to studying the overall problem of loading (orthogonally) ‘small boxes’ into ‘big boxes’ (e.g. Martello *et al.* 2007 and Pisinger 2002), quite recently, also different scenarios, allowing for spheres, cylinders and polyhedrons, are ever more taken into account (e.g. Egeblad *et al.* 2009, Stoyan and Chugay 2009 and Stoyan *et al.* 2003).

When no ‘transverse’ conditions (i.e. overall constraints relevant to the whole set of objects involved), such as those related to balancing, are stated, the loading task can be achieved by adopting a sequential procedure, simply consisting of placing the items one after the other and adopting a local optimization approach, as a matter of fact. This way, several real-world instances can efficiently be solved by smart (mainly heuristic) algorithms (e.g. Martello *et al.* 2000). Nevertheless, when overall conditions are present, it should be taken advantage, directly or indirectly, of Global Optimization (GO, e.g. Floudas and Pardalos 2001, Kallrath 2008, Liberti and Maculan 2005, Pardalos and Romeijn 2002 and Pintér 1996).

The cargo accommodation issues usually dealt with in space engineering, due to the specific geometries and constraints involved, typically define non-standard packing problems with additional conditions (also concerning, if necessary, the presence of fluids). Objects, quite often, can suitably be approximated as tetris-like items, i.e. clusters of mutually orthogonal parallelepipeds. This standpoint offers the opportunity of exploiting advantageous linear-wise structures in the relevant mathematical models.

The methodology employed by Thales Alenia Space to the purpose and referred to in this article (see Fasano 2013 and Fasano forthcoming) relates to the overall frameworks of GO (e.g. Minoux and Vajda 1986) and Mixed Integer Linear/nonlinear Programming (MIP/MINLP, e.g. Grossmann and Kravanja 1997, Kallrath 1999 and Nemhauser and Wolsey 1988). The CAST project has been funded by ESA to assist the ATV analytical cargo accommodation, in all its missions (c.f. [http://www.esa.int/Our\\_Activities/Human\\_Spaceflight/ATV](http://www.esa.int/Our_Activities/Human_Spaceflight/ATV)). Its rationale is outlined throughout this article, whilst discussing both the ATV and Columbus implementations. In Section 4, its potentiality of utilization, in different contexts too, is brought up.

Even at a first glance, it should result quite evident that, in the applicative context of reference, a manual approach would be impracticable. The cost-effectiveness of the approach followed, as well as its promptness to compare different operational scenarios and work out last-minute requests, is undoubtedly gathered by the human effort reduction. The high-quality outcomes moreover are granted by the advanced optimization framework put into action.

## 2. Automated transfer vehicle cargo accommodation

The ATV transportation system is intended to deliver both fluids and cargo items on-board the ISS. The vehicle is not supposed to return to Earth, since, following an attachment phase, it is destroyed on orbit (after being eventually detached from the ISS), together with an amount of

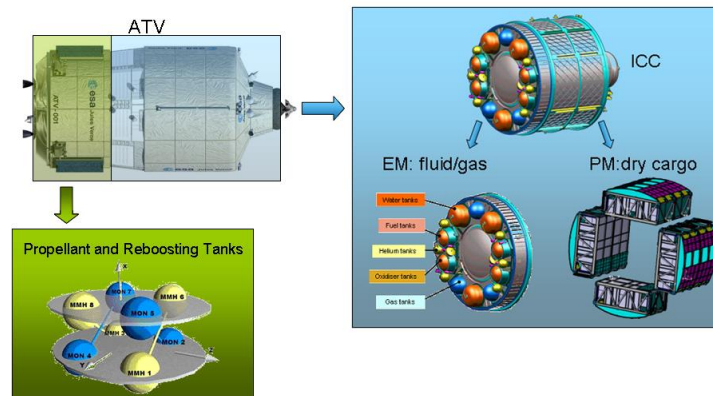

Fig. 1 ATV pressurized and external modules (PM/EM)

trash, produced by the station. In this section, only the up-load phase is discussed, as the loading aspects, relevant to the destructive re-entry, are significantly less demanding.

### 2.1 The problem

The up-load phase addresses both the un-pressurized and pressurized cargo. The first consists of fluids, whilst the second (commonly known as dry cargo) is represented by objects of different typologies. The Cargo Manifest supplies the list of all the relevant material that should be transported. Given lower and upper bounds determine, for each fluid type, the range of the amount requested. Some items may, however, be rejected, on the basis of a given priority, if the total demand results infeasible. The overall task is hence that of maximizing the overall load, in compliance with the specific features of the current vehicle (that can change from mission to mission).

From the cargo accommodation standpoint, the spacecraft consists essentially of two components. The un-pressurized module, denoted as external (EM), and the pressurized one (PM, see Fig. 1), respectively dedicated to the two corresponding kinds of cargo. The merging of these two modules is referred to, in the following, as system.

The fluids are transported in tanks, situated, with predefined positions, inside the external module. The relevant typologies, as contemplated by the Cargo Manifest, are:

- fuel;
- oxidizer;
- water;
- oxygen;
- nitrogen;
- air.

The set of available tanks consists of the following (see Fig. 2):

- 2 for the fuel;
- 2 for the oxidizer;
- 3 for the water;
- 3 for the gas.

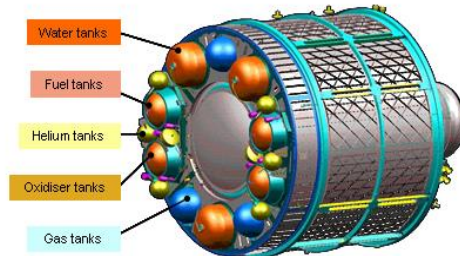

Fig. 2 External module tanks

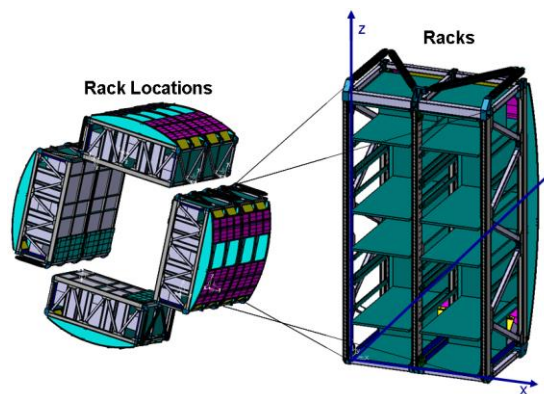

Fig. 3 Rack locations and racks

Fluid-tank compatibility and tank capacity represent the basic conditions to respect, in addition to specific loading rules:

- if the same fluid is loaded in more than one tank, the difference of mass between each pair of these cannot exceed a given amount (scattering rule);
- oxidiser/ fuel amounts must respect a given ratio (stated for stoichiometric reasons).

As far as the pressurized cargo is concerned, it is accommodated within its dedicated module, by means of appropriate racks that, when utilized, are inserted into proper structural facilities (see Fig. 3). These (called rack locations) are eight in all and have prefixed (axially symmetrical) positions inside the module (depending on the mission, the racks could be less than the available locations).

The anterior side of each rack (see Fig. 4), named rack front, is oriented towards the inside of the module (cf. Fig. 3). It can be equipped with four structural elements called adapter plates, aimed at holding items, externally, on the rack front. The posterior surface of the rack is curved, to match the cylindrical shape of the spacecraft (and thus exploit the available module volume, as much as possible). The internal rack volume is partitioned into sectors (of different kinds). There are two types of racks (whose details are not reported in this article), i.e. A and B. They present quite strong structural differences, implying, respectively, diverse cargo capacity and capability.

The two main classes of pressurized cargo are:

- cargo items;
- bags.

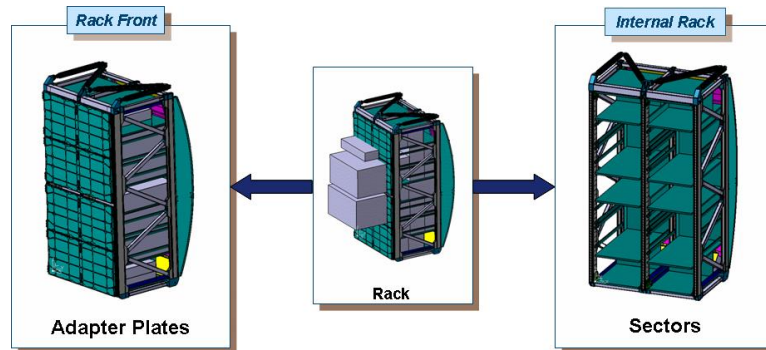

Fig. 4 Rack overall configuration

The cargo items are partitioned into the following typologies:

- small items;
- large items;
- external large items;
- mid-deck lockers (special items, named MDLs);
- drawers.

Small items, in general, are box-shaped (and assumed to be of homogeneous density), as well as MDLs and drawers. Large items, instead, are usually characterized by more complex forms and internal mass distribution. Albeit quite rarely, also small items with quite intricate shapes (and not irrelevant dimensions) that can hardly be approximated by single boxes, occur.

The overall accommodation rules can be summarized as follows:

- small items into standard bags (of different types);
- large items either into racks or on the rack fronts;
- internal bags and drawers into rack sectors;
- external bags, external large items and MDLs on the rack fronts;

Type A rack is able to accommodate all kinds of cargo items, while type B cannot contain/hold large items, MDLs and drawers (unless they are pre-packed inside bags). Compatibility/incompatibility conditions can be posed, dealing with the accommodation of the bags, due to operational needs. Frequently, for instance, some of them have to be grouped within the same sector or, at least, allocated together inside the same rack. On the contrary, others must not be accommodated by the same sector/rack.

Small items have to be accommodated, orthogonally, taking into account the mass capacity of the bags utilized (different from type to type). Quite often, additional conditions, like the following, hold:

- item prefixed position/orientation;
- presence of separation planes;
- minimum gap between items;
- static balancing.

The presence of separation planes (inside the bags), usually with variable positions, allows the item accommodation in different layers, making their handling easier for the astronauts acting on board (Fig. 5 shows items accommodated orthogonally in both box-shaped and curved bags; in one case, two separation planes are present and in others a given gap between items is considered).

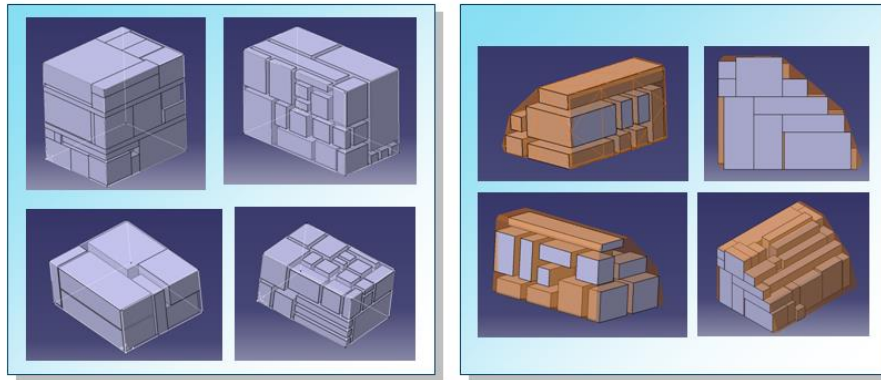

Fig. 5 Small items accommodation

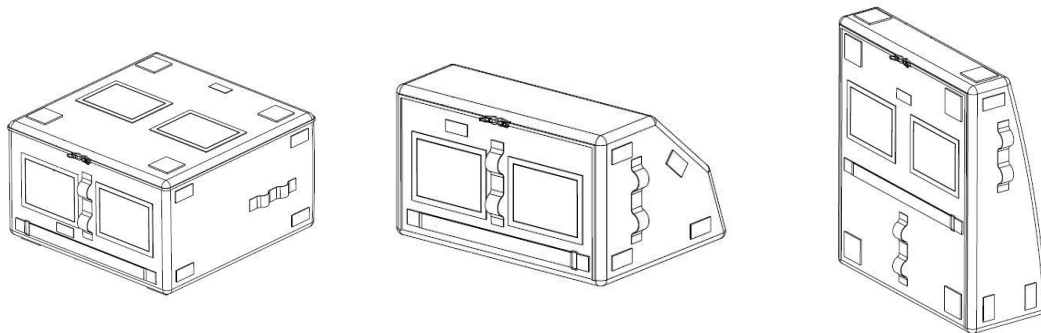

Fig. 6 Box-shaped and curved bags

The static balancing restriction (at bag level) states that the overall center of mass must stay within a cuboid (of given dimensions), positioned in the center of the box.

There are two main classes of bags:

- internal;
- external.

While the first are either box-shaped or curved (see Fig. 6), the second ones can only be box-shaped. Internal bags are accommodated inside the racks, while the external are placed on the rack fronts. The following types of internal bags, classified on the basis of their shapes and dimensions, are available.

Box-shaped:

- half;
- single;
- double;
- internal triple;

Curved-shaped:

- type A;
- type B.

Only one kind of external bags is envisaged:

- external triple.

Box-shaped internal bags are modular. Consequently, two halves may be joined to replace a single, two singles a double, a single plus a double a triple, and so on. Depending on the incumbent Cargo Manifest to satisfy, a number of internal/external bags could already be pre-integrated. In such cases, their internal load is kept as it is, without any possibility of adding further items inside the bags.

A number of additional conditions, at system level, have to be taken into account:

- mass capacity;
- static balancing;
- dynamic balancing.

The total cargo (un-pressurized plus pressurized), indeed, cannot exceed a given threshold. The static balancing requirement states that the system center of mass co-ordinates must stay within given ranges that depend on the total mass loaded. The dynamic balancing conditions, essentially, compel the system inertia matrix, defined with respect to a proper axial reference frame, with its origin positioned in the overall center of mass, to take on a quasi-diagonal form. Lower and upper bounds, expressed as (continuous) functions of the loaded mass, are, moreover, posed. The dynamic balancing constraints provide, as a matter of fact, the system with a mechanical behavior approximately equivalent to that of a homogeneous cylinder. These conditions can be formulated as follows (see Fasano forthcoming):

$$\begin{aligned} \forall \beta, \beta' \in B / \beta < \beta' & \quad \left| \sum_{i \in I} M_i w_{\beta i} w_{\beta' i} \right| \leq \bar{I}_{\beta \beta'}(m) \quad , \\ \forall \beta, \beta', \beta'' \in B / \beta < \beta', \beta, \beta' \neq \beta'' & \quad \sum_{i \in I} M_i (w_{\beta i}^2 + w_{\beta' i}^2) \geq \underline{I}_{\beta''}(m) \quad , \\ \forall \beta, \beta', \beta'' \in B / \beta < \beta', \beta, \beta' \neq \beta'' & \quad \sum_{i \in I} M_i (w_{\beta i}^2 + w_{\beta' i}^2) \leq \bar{I}_{\beta''}(m) \end{aligned}$$

Here: the indexes  $\beta$  indicate the reference frame axes,  $w_{\beta i}$  are the center of mass coordinates associated to each item  $i$ ,  $M_i$  the object masses, whilst  $\bar{I}_{\beta \beta'}(m)$ ,  $\underline{I}_{\beta''}(m)$  and  $\bar{I}_{\beta''}(m)$  are (non-negative) functions of the total loaded mass  $m$  (in this formulation the inertia property relevant to each item are neglected).

The actual accommodation of cargo items and bags inside the racks or externally, on the rack fronts, is regulated by extremely tricky rules (not reported here). They are quite different from each other, depending on the type of racks/sectors/items/bags utilized. Some control the positioning of each single kind of item/bag, either inside the various sector types, or on the rack front. Others, concerning the placement of sets of items/bags inside the same sector or rack front, essentially inhibit incompatible configurations.

The following overall conditions, at rack level, have, moreover, to be considered:

- overall mass capacity;
- external mass capacity;
- sector mass capacity;
- rack front mass capacity;
- static balancing.

The static balancing restriction, in this case, imposes that the rack center of mass is contained inside a given convex domain (see Fig. 7).



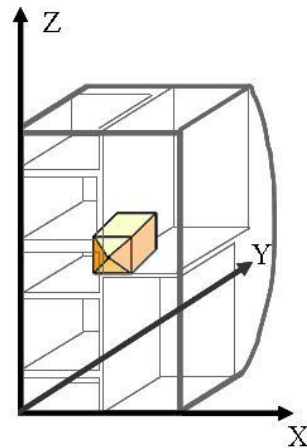

Fig. 7 Rack center of mass (convex) domain

## 2.2 The loading procedure

The accommodation problem explained in Section 2.1, although presented in quite a simplified version with respect to its actual statement, shows itself as extremely complex. Some cargo accommodation exercises, related to the ISS logistic context, were, fairly recently, carried out efficiently, employing Artificial Intelligence (Daughtrey 1991) or multi-agent methods (Takadama 2004). Nonetheless, a mathematical-programming-based approach, supported by dedicated heuristics, definitely seemed more suitable for the case in question than these methodologies, or meta-heuristics in general (Blum and Roli 2003, Glover and Kochenberger 2003 and Voss *et al.* 1999). The ATV issue, indeed, appeared much more difficult, due to the very significant number of mandatory requirements to cope with, in addition to the tight balancing restrictions. An ad hoc approach, tailored to the specific cargo accommodation scenario, has hence been studied. As the given problem could unquestionably not be solved, tout court, as a whole, taking into account contemporarily all the relevant accommodation levels (i.e. bag, rack, system), a heuristic procedure, decomposing the whole problem into sub-problems, has been devised (Fasano 2009).

CAST implements an overall architecture (see Fig. 8), based on a mathematical library that represents the core of the whole optimization framework. Sub-problems are solved iteratively by adopting, step by step, the relevant mathematical library module (consisting of specific MIP models and heuristic algorithms). These are handled by an overall System Management module (CAST-SM) and a (3D) Graphical User Interface (CAST 3D-GUI). Backward iterations are foreseen, when the desired solution is not attained, performing a recursive process.

In the present CAST versions, the mathematical library consists of the following modules:

- Item Accommodation (IA);
- Preprocessing Assessment (PPA);
- Item-Rack Correlation (IRC);
- Rack Configuration (RC);
- Cargo (overall) Accommodation (CA).

(For in-depth discussions and technical details on the underlying mathematical models and ad hoc optimization algorithms, see Fasano 2013, Fasano forthcoming).

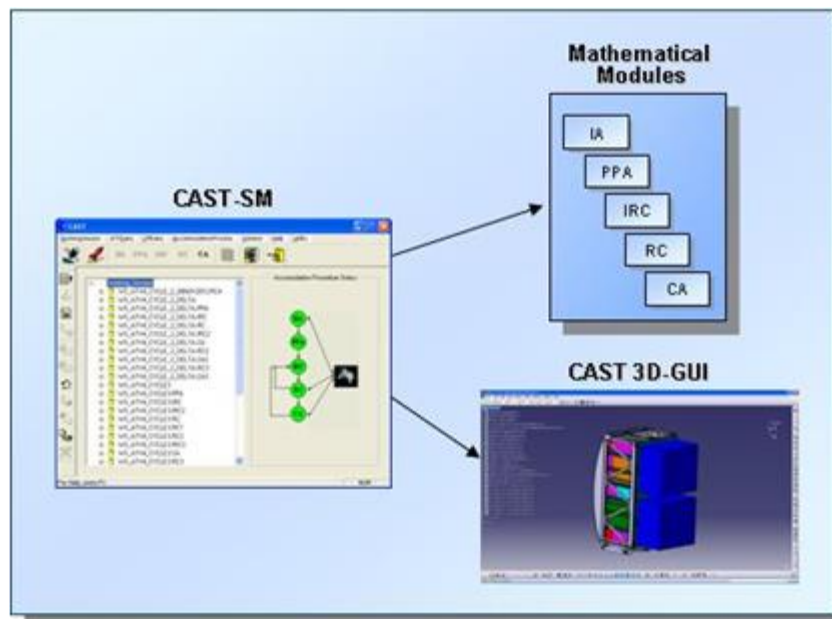

Fig. 8 CAST basic components

The IA module is employed to accommodate the small items inside bags, on the basis of the general packing rules and possible additional ones (see Section 2.1), if any. When particular cases, involving items that can hardly be modeled as single boxes arise, an ad hoc tetris-like formulation is considered.

The PPA is aimed at attaining quite an approximate accommodation both of the fluid and pressurized cargo. This module allows a preliminary feasibility check. At this step, also the pressurized load is considered as fluid. The static and dynamic balancing conditions are considered at system level (see Section 2.1).

The objective targeted by the IRC is that of obtaining an initial correlation between cargo items or pre-integrated bags and the rack locations. At this stage, items are modeled as flexible (i.e. they are considered in terms of mass and volume only, neglecting their actual dimensions). The static and dynamic balancing conditions are considered at system level (see Section 2.1). Cargo items and pre-integrated bags may be rejected, if necessary, on the basis of their priority.

The RC module has the task of defining the internal/external rack loading (taking into account specific accommodation rules). Integrated bags, drawers, large items, and MDLs are accommodated into the racks or on the rack fronts, on the basis of the designations provided by the IRC stage. All cargo items and bags involved have, in this phase, their actual shapes and dimensions. The static balancing restriction (at rack level) is respected.

Since, going along the whole accommodation process, several approximations are, step by step, directly or indirectly admitted, the CA module has the objective of rearranging all the partial so-far obtained outcomes, in order to obtain an ultimate result. The assignment of the already accommodated racks is reconsidered, looking into a final accommodation, compliant with the given static and dynamic balancing conditions (at system level). At this final step, a quantity of load can still be rejected, if necessary, and this reduction, is, as obvious, minimized.

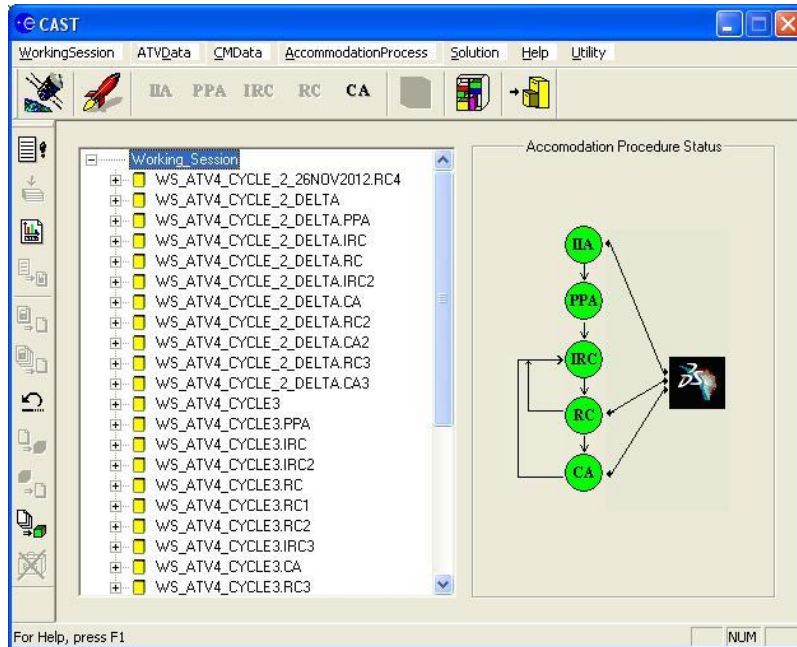

Fig. 9 Example of CAST-SM control panel

The major functions associated to the CAST-SM module (see Fig. 9) are:

- managing the ATV system and Cargo Manifest data, relevant to the current mission;
- executing, step by step, the predisposed mathematical models;
- showing the ongoing and final accommodation status;
- exporting the final accommodation solution to the dedicated database.

The CAST 3D-GUI provides the cargo engineer with graphical representations of the current and final outcomes, at bag and rack level, with the possibility of interacting during the process or making desirable changes in the final solutions (it is gathered that some human-perception-based evaluative criteria can hardly be contemplated by mathematical models).

### 2.3 Applicative scenario

CAST is designed to perform the entire end-to-end accommodation cycle, allowing the comparison of different operative scenarios, in order to attain the best trade-off between technical specifications and implementation costs. Illustrative representations of real-world solutions follow.

Quite dense item-bag packing, obtained by CAST (as a test case), is showed in Fig. 10 (detailed information on solution quality and computational performances, related to this class of problems, can be found in: Fasano forthcoming). Fig. 11 illustrates a case study involving tetris-like items (inside a curved bag, with a separation plane). The placement of two external large items on the rack front is instead displayed by Fig. 12. and Fig. 13, provides, moreover, a typical representation of the center of mass projections, at rack level, within the given domain.

In addition to the outcomes relevant both to bag and rack levels, the overall results, concerning the external and pressurized modules, as well as the complete system, are of major interest. Fig. 14

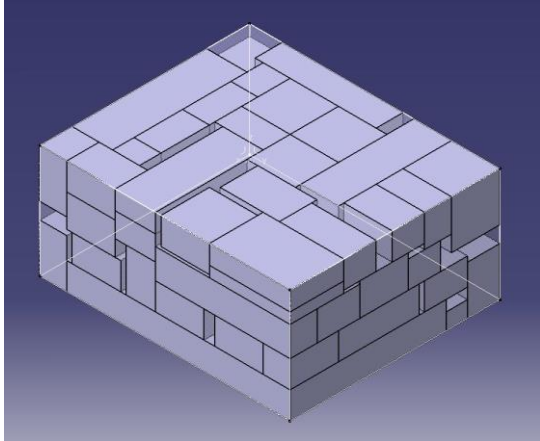

Fig. 10 Example of bag level packing solutions

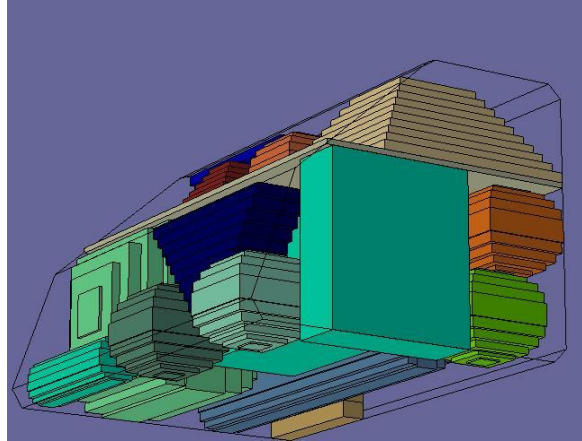

Fig. 11 Example of tetris-like items

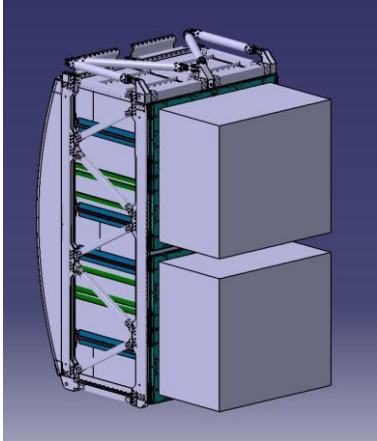

Fig. 12 Example of external accommodation

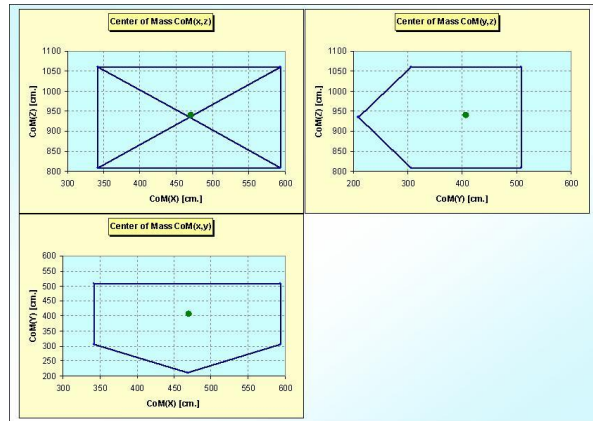

Fig. 13 Example of rack center of mass projections

provides a typical tabular representation of these general solutions (provided by the CA module). On the left, the mass loaded (out of the maximum allowed for the mission considered), per fluid type, is reported (in the specific case displayed by the Fig. 14, some fluid types are not requested). In the middle, the loaded un-pressurized and pressurized cargo, respectively, are showed. On the right, the accommodated mass per rack is represented.

The following figures are related to the overall static and dynamic balancing. Fig. 15, in particular, displays the overall system center of mass position, referred to the longitudinal reference frame axis. The envelope delimited by the lower and upper bound functions (depending on the total mass loaded) is visible. Fig. 16 represents the inertia moment relative to the longitudinal reference frame axis, inside the relevant domain.

CAST is expected to tackle complex large-scale instances, involving up to 1000 items, 8 racks and 80 sectors, although real-world scenarios are usually less demanding. On the basis of the practical experience available to date, it is sensible to assume that a satisfactory analytical accommodation is achievable in less than one week (including all possible interactions, design readjustments and trade-offs between different solutions).



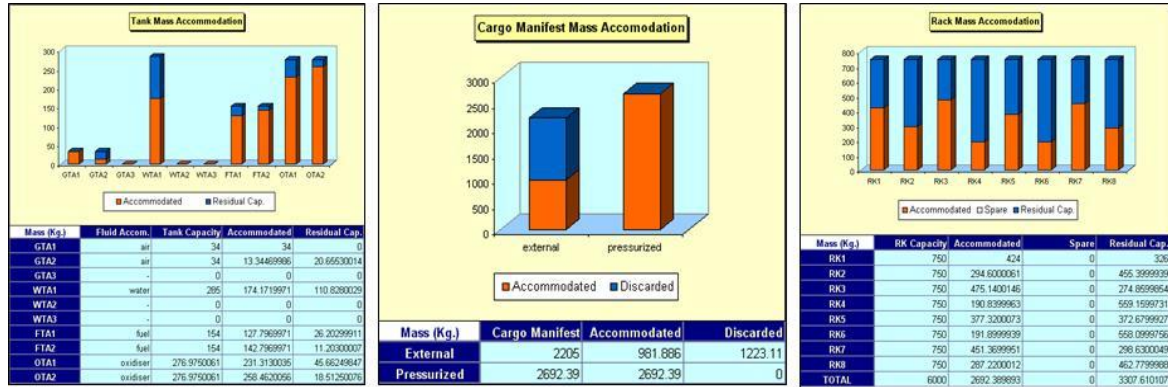

Fig.14 Example of mass distribution at overall level

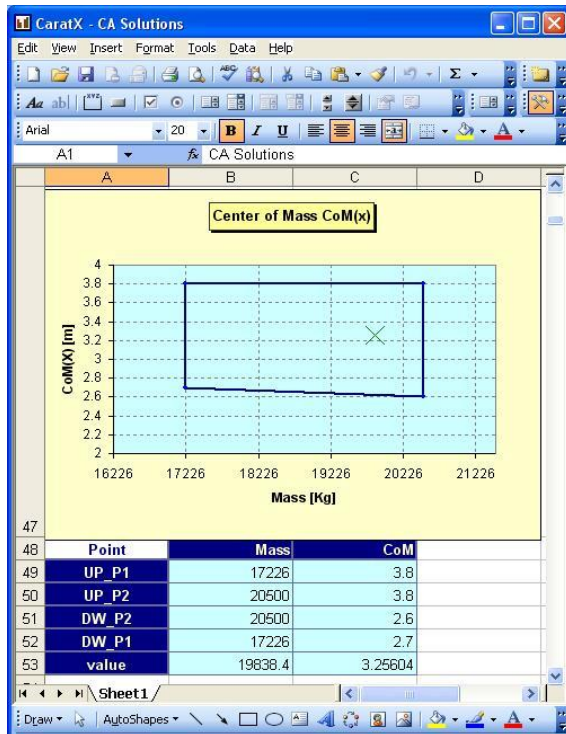

Fig. 15 Example of system center of mass projection (longitudinal axis)

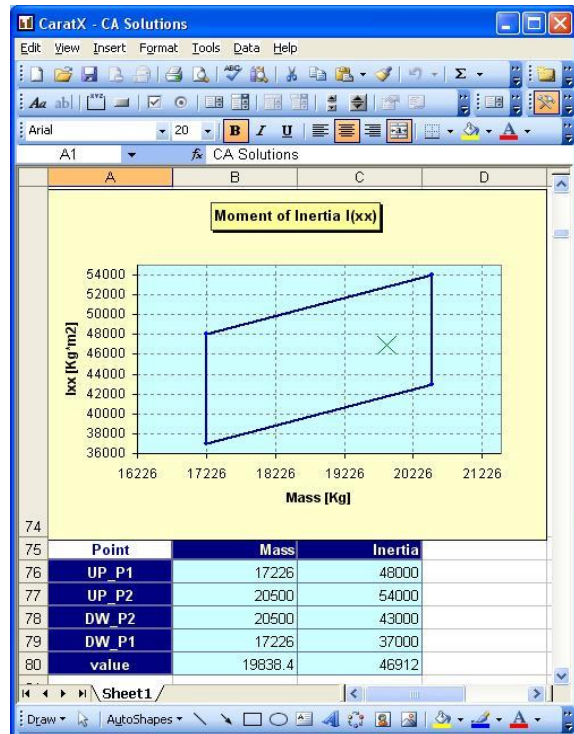

Fig. 16 Example of inertia moment (longitudinal axis)

### 3. Columbus on-board stowage

The ISS maintenance is accomplished through the periodic resupply interventions (on approximately a quarterly basis), carried out by means of the available cargo carriers. This implies the capability of storing both the logistic material and the load supposed to be transported back to Earth or destroyed, during re-entry missions. At each up/down-load step, the on-board stowage has

to be promptly rearranged and this, obviously, entails the capability to rapidly readapt the current scenario to the updated status.

The on-board stowage creates a strong impact on habitability and crew productivity. As a consequence, when exploiting the on-board volume left available by the downloaded cargo, safety, ergonomic needs and operational feasibility must, in no way, be ignored. A number of mandatory stowage constraints, applicable to the whole space station's framework have therefore been stated. As it is clearly gathered, the stored material is not allowed, for instance, to inhibit emergency interventions; to interfere with the equipment designated for critical safety operations; to reduce the usability of devices. All these kinds of stumbling blocks, directly or indirectly, generate a non-negligible quantity of quite demanding accommodation rules.

The Columbus module (see [http://www.esa.int/Our\\_Activities/Human\\_Spaceflight/Columbus](http://www.esa.int/Our_Activities/Human_Spaceflight/Columbus)), designed as an attached laboratory initially, with the sole scope of supporting the station experimental activity (fluid physics, new materials, life science and earth observation), is nowadays also utilized as a stowage facility. The relevant accommodation issue is quite difficult. It is dealt with by a dedicated CAST version (denoted by C-CAST, see Fasano *et al.* 2010), discussed hereinafter.

### 3.1 Background and dedicated approach

As far as the on-board stowage problem is concerned, Columbus has room for up to ten racks (see Fig. 17 and Fig. 18), eight of which are situated in the sidewalls, and two in the ceiling area. As in the ATV case, they are also provided with internal sectors of different types and corresponding mass capacities. The research equipment housed inside the module is located all together into five racks. The stowage material does not contemplate, in this case, the presence of fluids. The relevant items can be placed into the rack sectors, on the basis of their availability, adopting specific accommodation rules (less complex than those taken into account in the ATV context).

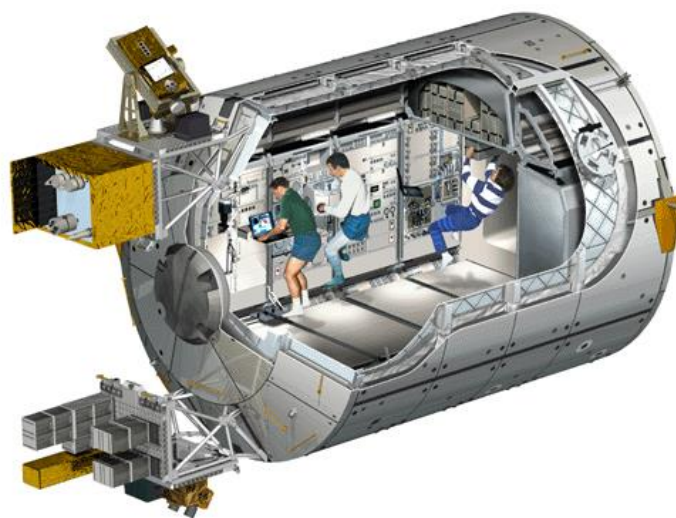

Fig. 17 The Columbus laboratory



Fig. 18 Columbus racks

A first optimization objective is evidently that of including the full list of items, in compliance with the current Cargo Manifest, minimizing, also in this case, the number of the rejected ones (on the basis of their priority). Mandatory requirements, deriving from ergonomic and operational needs, quite often impose the grouping of some items inside the same sector/rack, or, on the contrary, define incompatibility conditions. A number of forbidden positions can sometimes make the accommodation task quite tricky.

The concern of sparing the crew workload, as much as possible, induces, as a first attempt, keeping the items already uploaded in their acquired positions, within their assigned racks. If strictly necessary, solely in order to prevent the rejection of some items, they can nonetheless be reallocated differently. Once an optimal solution, identifying the maximum loadable cargo, in compliance with all the accommodation requirements, has been found, a post-optimization is performed. It has the scope of re-allocating, within each rack, some items, in order to minimize the residual volume of the sectors that are to be utilized. In such a way, a larger number of totally empty sectors are made available for the next upload steps, facilitating the subsequent accommodation task.

At each up/down-load step, as in the ATV case, a multilevel optimization process is executed through different packing sub-problems. Although the current objective has been achieved, the cargo engineer is, however, still asked to perform a further task. How could residual volumes (if there are any left by the above mentioned post-optimization) be suitably exploited in the next resupply steps? Or, alternatively, what kind of items could fill the remaining empty volumes properly? A further optimization process is therefore dedicated to identifying a number of hole-filling virtual items (see Fasano and Vola 2013), in order to support the forthcoming upload plan activity, in cooperation with the Cargo Manifest team. An example of virtual items is showed in Fig. 19 (outside the rack).

### 3.2 Practice in the field

As the original CAST version, C-CAST provides two/three-dimensional representations of the solutions, in addition to synoptic tables and diagrams, see Fig. 20. A typical stowage solution

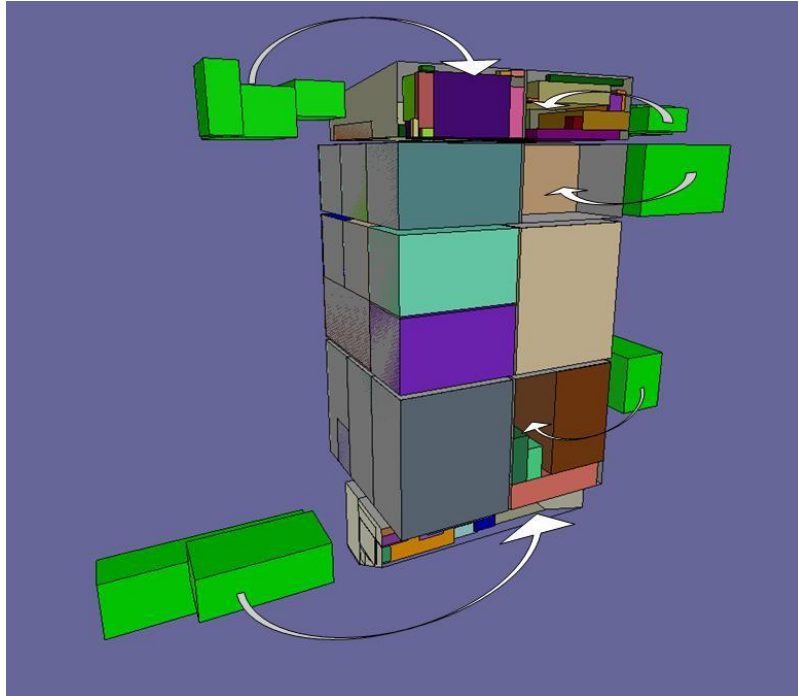

Fig. 19 Identification of virtual items

obtainable by the tool is illustrated by Fig. 21. A case study, aimed at reallocating items inside the same rack, following the rationale outlined above, is shown by Fig. 22 that compares a handmade solution (left) with the one obtained automatically by C-CAST.

On the basis of the expertise gained so far, satisfactory accommodations (following the post-optimization stage) are expected in less than one hour in all, opposed to two/three days that is approximately the time needed by a manual approach. This dramatically reduces the cargo engineer effort, significantly increasing the average filling coefficient of the utilized sectors (with a foreseen increment of more than 20%).

In order to exploit the empty volumes inside the module as much as possible, quite atypical (i.e. non-rack-based) accommodations can also be investigated. An interesting instance deals with the Columbus' starboard end cone (see [http://www.esa.int/Our\\_Activities/Human\\_Spaceflight/Columbus](http://www.esa.int/Our_Activities/Human_Spaceflight/Columbus)). Items may be placed inside, once it assumes the complementary stowage task. In such a case, the presence of structural elements and the resulting clearance zones has to be taken into account. Fig. 23 depicts the exploitable volume, on the left. On the right, items (in colour) are placed in compliance with the relevant forbidden spaces (grey colored).

In order to exploit the empty volumes inside the module as much as possible, quite atypical (i.e. non-rack-based) accommodations can also be investigated. An interesting instance deals with the Columbus' starboard end cone (see [http://www.esa.int/Our\\_Activities/Human\\_Spaceflight/Columbus](http://www.esa.int/Our_Activities/Human_Spaceflight/Columbus)). Items may be placed inside, once it assumes the complementary stowage task. In such a case, the presence of structural elements and the resulting clearance zones has to be taken into account. Fig. 23 depicts the exploitable volume, on the left. On the right, items (in colour) are placed in compliance with the relevant forbidden spaces (grey colored).



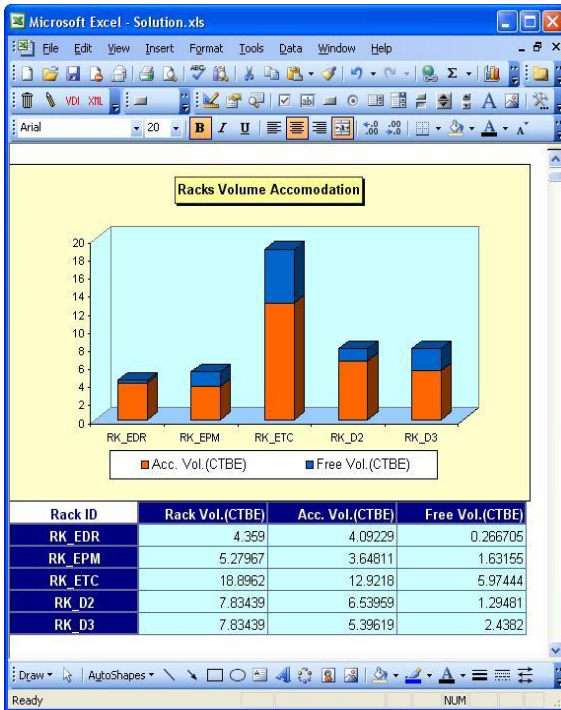
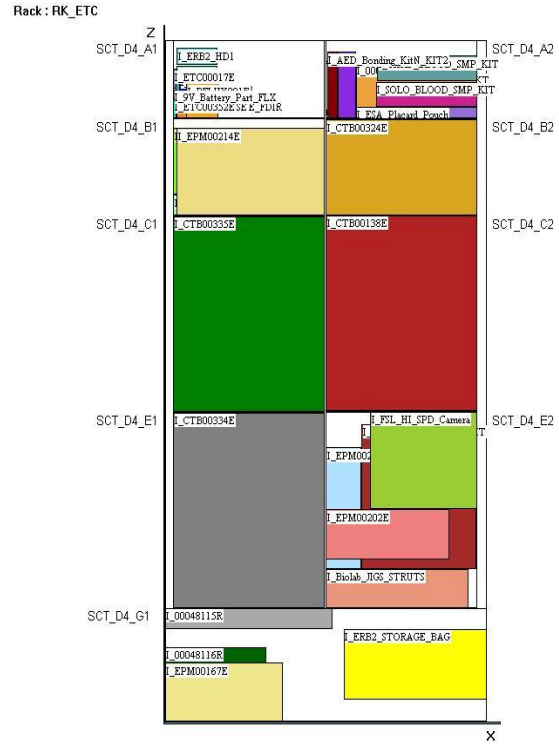
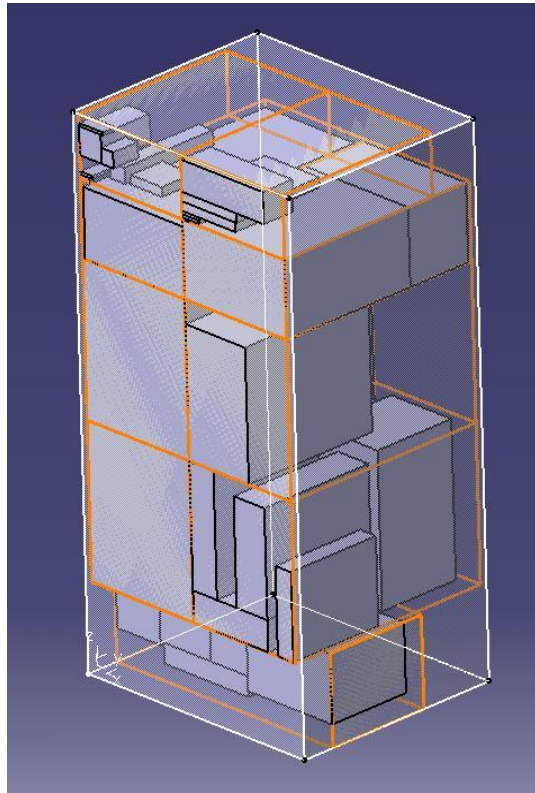

Accommodation Status

**Racks Accommodation Table**

Rack ID	Acc.Volme(CTBE)	Free Volume(CTBE)	Mass Acc.(Kg)	CoM X(mm)	CoM Y(mm)	CoM Z(mm)
RK_EDR	3.0044	1.3546	0	0	0	0
RK_EPM	3.79607	1.4836	0	0	0	0
RK_ETC	14.3063	4.58994	0	0	0	0
RK_D2	6.53959	1.29481	0	0	0	0
RK_D3	5.39619	2.4382	0	0	0	0

**Sectors Accommodation Table**

Sector ID	Rack ID	Sector Volume(CTBE)	Acc. Volume(CTBE)	Free Volume(CTBE)	Acc. Mass(Kg)
SCT_FL_E1	RK_EDR	1.08975	1.00146	0.0882848	0
SCT_FL_E2	RK_EDR	1.08975	0	1.08975	0
SCT_FL_E3	RK_EDR	1.08975	1.00146	0.0882848	0
SCT_FL_E4	RK_EDR	1.08975	1.00146	0.0882848	0
SCT_AL_E1	RK_EPM	1.58529	1.00273	0.582561	0
SCT_AL_E2	RK_EPM	1.58529	0.790758	0.79453	0
SCT_AL_E3	RK_EPM	1.45	1.45	0	0
SCT_AL_E4	RK_EPM	0.659091	0.552582	0.106509	0
SCT_D4_A1	RK_ETC	0.965909	0.133955	0.831954	0
SCT_D4_A2	RK_ETC	0.965909	0.462253	0.503656	0
SCT_D4_B1	RK_ETC	1.49716	1.18691	0.310249	0
SCT_D4_B2	RK_ETC	1.49716	1.46883	0.0283286	0
SCT_D4_C1	RK_ETC	3.03054	3.0259	0.00463788	0
SCT_D4_C2	RK_ETC	3.03054	1.96272	1.06782	0
SCT_D4_E1	RK_ETC	3.03054	3.0259	0.00463788	0

Fig. 20 C-CAST solution representations

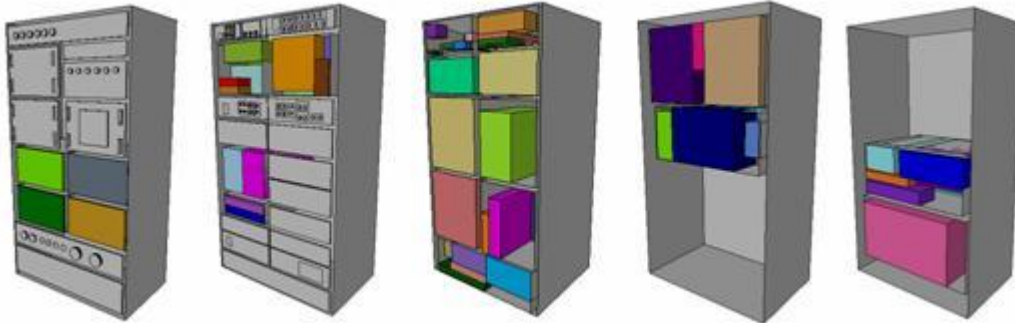

Fig. 21 Stowage accommodation typology

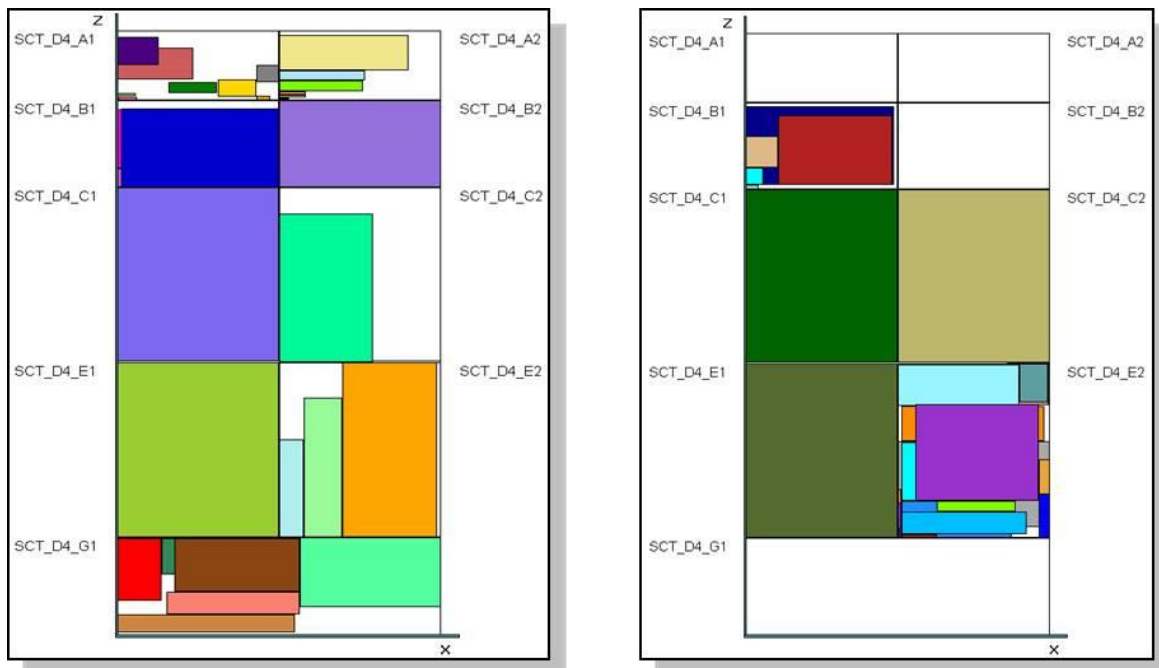

Fig. 22 Case study internal reallocation

#### 4. Potential extensions

The overall methodology referred to in this article is quite clearly subject to possible extensions to closely related issues of some interest. Relevant insights are briefly brought up in this section, in order to suggest prospective development directions.

Firstly, it is worth noticing that a wide range of cargo accommodation applications can easily be foreseen, in the perspective of the quite challenging space programs of the near future. The design of further modules and vehicles, even inserted in an ever-expanding commercial

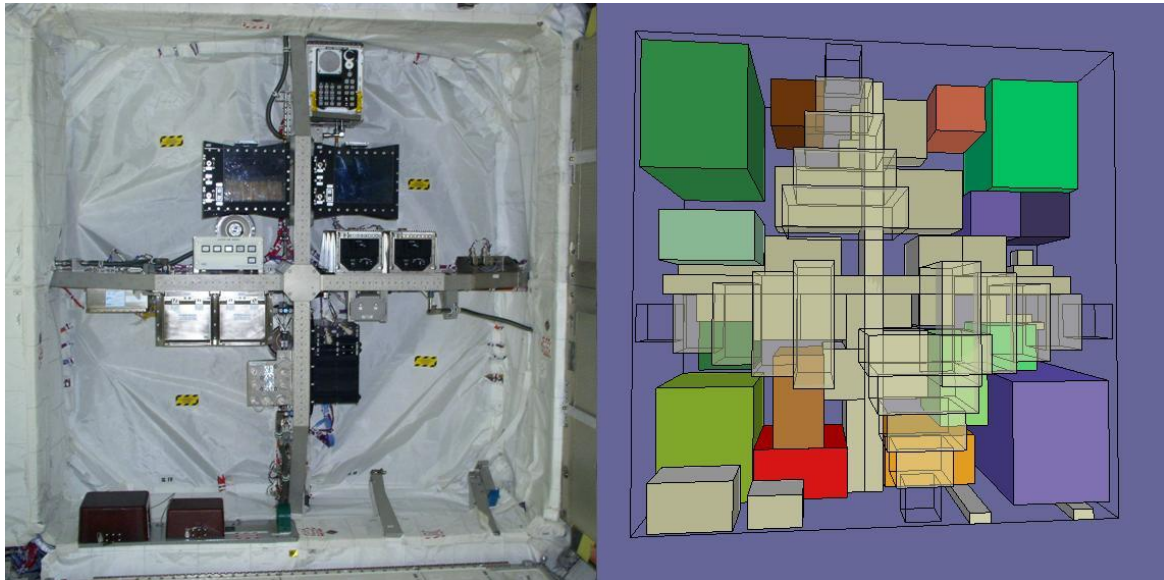

Fig. 23 Columbus' starboard end cone exploitation

environment, are expected to be carried on, with growing effort. Inflatable systems will present an innovative direction of development, posing specific cargo accommodation issues. Additionally, a leading role, also for the subject in question, will certainly be taken by the future manned space missions, such as the ones concerning the lunar bases, for which the optimization of the inhabited volumes will represent a major objective.

Further quite interesting applications could deal with the so called payload accommodation issue, inside modules, usually implying both scheduling and packing aspects. Technically, a payload is equipment, devoted to the on-board experimental activity. It consists of a set of facilities, with specific resource requirements (generally related to crew time, electrical power and water/air cooling). Payloads usually have to be accommodated into pre-defined positions, provided with different resource availability. This has to be utilized as efficiently as possible, in order to accomplish the experimental tasks requested. As a consequence, the payload assignment to the predisposed locations gives rise to a non-trivial optimization problem. A major objective consists of finding satisfactory time-dependent solutions, i.e. feasible accommodations, in compliance with the payload operational constraints and the overall availability of resources.

An important topic, solely in appearance scarcely correlated to the cargo accommodation one, concerns, moreover, the on-orbit unloading of modules/vehicles. This problem, for instance, arises in the ATV mission scenario, during its attachment phase (usually taking approximately six months), before the destructive re-entry. Since (for emergency reasons) the vehicle must be able to depart from the station at any moment, it permanently has to be compliant with all the given balancing requirements. Whilst the cargo accommodation analysis certainly represents a demanding task, as it results from the previous sections of this article, the issues related to the on-orbit unloading are, altogether, not any easier. In this context, indeed, accurate operational paradigms are mandatory. These can be achieved by proper cargo-removal procedures, implying, if necessary, temporary exchanges/repositioning of items, so that, at each step, no constraint/bound violations can occur.

In addition to what has been briefly mentioned so far, some considerations may be made, focusing on aspects still related to the cargo accommodation overall task, albeit addressing different points of view. Indeed, when dealing with the early phases of the entire cargo accommodation process, or even during the design of the spacecraft itself (where sizing investigations of the system are needed), a significant level of uncertainty, relevant to the prospective load characteristics, has to be expected. On the basis of the information, time after time available, a dedicated worst-case analysis could be carried out by readapting the overall optimization methodology presented here. To this purpose, proper (opposite-oriented) objective functions, aimed at looking for the worst solutions, e.g. accommodations attaining the maximum overall center of mass distance from the desired position, should be introduced.

## 5. Conclusions

This article focuses on the issue commonly referred to, in space engineering, as cargo accommodation. The relevant task is well known for being, in general, very challenging. Highly complicated operational scenarios usually have to be coped with, allowing for complex geometries and the presence of demanding conditions, such as static and dynamic balancing. The problem is supposed to be worked out as efficiently as possible, in quite a restricted time lapse, so that it is even too obvious that a paper-and-pencil-based approach could hardly serve the purpose.

Benefiting from an extensive research and development effort, the company has set up a dedicated framework, up to adequately tackling the requested cargo accommodation of space modules and vehicles. CAST, developed on ESA funding, is an advanced system conceived with the precise objective of carrying out the relevant activity, in aid of all the missions planned for the Automated Transfer Vehicle (ATV). Based on ad hoc optimization models and algorithms, it follows an overall heuristic procedure, aimed at obtaining satisfactory solutions with reasonable time consumption.

This article firstly introduces the cargo accommodation problem on the whole. Afterwards, the specific ATV context is investigated, providing insights on its intrinsic difficulties. CAST underlying methodology is subsequently outlined. The application to the on-board stowage analysis, relative to the Columbus attached module, is also described. The approach proposed is most certainly up to supporting further extensions of which some are, in addition, brought up.

## References

- Blum, C. and Roli, A. (2003), "Metaheuristics in combinatorial optimization: overview and conceptual comparison", *ACM Comput. Surv.*, **35**(3), 268-308.
- Cagan, J., Shimada, K. and Yin, S. (2002), "A survey of computational approaches to three-dimensional layout problems", *Comput. Aided Design*, **34**, 597-611.
- Daughtrey, R.S. (1991), "A simulated annealing approach to 3-D packing with multiple constraints", Cosmic Program MFS28700, Boeing Huntsville AI Center Huntsville, Alabama.
- Dyckhoff, H., Scheithauer, G. and Terno, J. (1997), *Cutting and packing*, In: Dell'Amico, M., Maffioli, F., Martello, S. (eds.), *Annotated bibliographies in combinatorial optimization*, John Wiley & Sons, Chichester, 393-412.
- Egeblad, J., Nielsen, B.K. and Brazil, M. (2009), "Translational packing of arbitrary polytopes", *Comput. Geometry*, **42**(4), 269-288.

- Floudas, C.A. and Pardalos, P.M. (2001), *Encyclopedia of optimization*, Kluwer Academic Publishers, Dordrecht, The Netherlands.
- Fasano, G. (2009), “A multi-level MIP-based heuristic approach for the cargo accommodation of a space vehicle”, *6<sup>th</sup> ESICUP Meeting*, Valencia, Spain, March 25-29.
- Fasano, G. (2013), “A global optimization point of view to handle non-standard object packing problems”, *J. Global Optim.*, **55**(2), 279-299.
- Fasano, G. (forthcoming), *Solving non-standard packing problems by global optimization and heuristics*, SpringerBrief in Optimization.
- Fasano, G., Saia, D. and Piras A. (2010), “Columbus stowage optimization by CAST (Cargo Accommodation Support Tool)”, *Acta Astronaut.*, **67**(3-4), 489-495.
- Fasano, G. and Vola, M.C. (2013), “Space module on-board stowage optimization exploiting containers’ empty volumes”, In: Fasano, G., Pintér, J.D. (eds.), *Mod. Optim. Space Eng.*, 249-269. Springer Science + Business Media, New York
- Glover, F. and Kochenberger, G.A. (2003), *Handbook of metaheuristics*, Springer, International Series in Operations Research & Management Science.
- Grossmann, I.E. and Kravanja, Z. (1997), *Mixed integer non-linear programming: a survey of algorithms and applications*, In: Biegler, L.T., Coleman, T.F., Conn, A.R., Santosa, F.N. (eds.) *Large-scale optimization with applications*, 73-100. Springer-Verlag, New York, Inc.
- Hillier, F.S. and Lieberman, G.J. (2001), *Introduction to operations research*, McGraw-Hill Companies, New York.
- <http://www.esa.int> (European Space Agency, ESA).
- [http://www.esa.int/Our\\_Activities/Human\\_Spaceflight/ATV](http://www.esa.int/Our_Activities/Human_Spaceflight/ATV) (European Space Agency, ESA, Automated Transfer Vehicle).
- [http://www.esa.int/Our\\_Activities/Human\\_Spaceflight/Columbus](http://www.esa.int/Our_Activities/Human_Spaceflight/Columbus) (European Space Agency, ESA, Columbus Laboratory).
- <http://glossary.computing.society.informs.org> (INFORMS Computing Society: Mathematical Programming Glossary).
- <http://www.jaxa.jp> (Japan Aerospace Exploration Agency, JAXA).
- <http://www.nasa.gov> (National Aeronautics and Space Administration NASA)
- <http://www.roscosmos.ru> (Russian Federal Space Agency, ROSCOSMOS).
- Ibaraki, T., Imahori, S. and Yagiura, M. (2008), *Hybrid metaheuristics for packing problems*, In: Blum, C., Aguilera, M.J., Roli, A., Sampels, M. (eds.), *Hybrid Metaheuristics: an emerging approach to Optimization. Studies in Computational Intelligence (SCI)*, **114**, 185-219, Springer, Berlin.
- Kallrath, J. (1999), *Mixed-integer nonlinear applications*, In: Ciriani, T., Ghiozzi, S., Johnson, E.L. (eds.), *Operations research in industry*, 42-76. Macmillan, London.
- Kallrath, J. (2008), *Modeling difficult optimization problems*, In: Floudas C.A., Pardalos P.M. (eds.), *Encyclopedia of optimization*, 2284-2297, 2<sup>nd</sup> Edition, Springer, New York.
- Liberti, L. and Maculan, N. (eds.) (2005), *Global Optimization: From Theory to Implementation*, Springer Science + Business Media, New York.
- Martello, S., Pisinger, D. and Vigo, D. (2000), “The three-dimensional bin packing problem”, *Oper. Res.*, **48** (2), 256-267.
- Martello, S., Pisinger, D., Vigo, D., Den Boef, E. and Korst, J. (2007), “Algorithms for general and robot-packable variants of the three-dimensional bin packing problem”, *ACM T.Math. Software.*, **33**(1).
- Minoux, M. and Vajda, S. (1986), *Mathematical programming: theory and algorithms*, John Wiley & Sons, Inc., London.
- Nemhauser, G.L. and Wolsey, L.A. (1988), *Integer and combinatorial optimization*, John Wiley & Sons Inc, NewYork.
- Pardalos, P.M. and Romeijn, H.E. (2002), *Handbook of global optimization*, Kluwer, Dordrecht, The Netherlands.
- Pintér, J.D. (1996), *Global optimization in action*, Kluwer Academic Publishers, Dordrecht, The Netherlands.

- Pisinger, D. (2002), "Heuristics for the container loading problem", *Eur. J. Operat. Res.*, **141**(2), 382-392.
- Preparata, F.P. and Shamos, M.I. (1988), *Computational geometry - an introduction*, Springer-Verlag, New York.
- Stoyan, Y.G. and Chugay, A.M. (2009), "Packing cylinders and rectangular cuboids with distances between them into a given region", *Eur. J. Operat. Res.*, **197**, 446-455.
- Stoyan, Y.G., Yaskov, G. and Scheithauer, G. (2003), "Packing of various radii solid spheres into a parallelepiped", *Central Eur. J. Operat. Res.*, **11**(4), 389-407.
- Takadama, K., Tokunaga, F. and Shimohara, K. (2004), "Capabilities of a multiagent-based cargo layout system for H-II transfer vehicle", *16th IFAC Symposium on Automatic Control in Aerospace (ACA'04)*, St. Petersburg, Russia, June 14-18.
- Voss, S., Martello, S., Osman, I.H. and Roucairol, C. (1999), *Meta-heuristics: advances and trends in local search paradigms for optimization*, Kluwer, Dordrecht.
- Williams, H.P. (1993), *Model building in mathematical programming*, John Wiley & Sons, London.

EC